

This manual should be considered a permanent part of the motorcycle and should remain with the motorcycle when it is resold.

This publication includes the latest production information available before printing. Honda Motor Co., Ltd. reserves the right to make changes at any time without notice and without incurring any obligation.

No part of this publication may be reproduced without written permission.

The vehicle pictured in this owner's manual may not match your actual vehicle.

© 2013 Honda Motor Co., Ltd.

<http://www.motorcycle.in.th>

# Welcome

Congratulations on your purchase of a new Honda motorcycle. Your selection of a Honda makes you part of a worldwide family of satisfied customers who appreciate Honda's reputation for building quality into every product.

To ensure your safety and riding pleasure:

- Read this owner's manual carefully.
- Follow all recommendations and procedures contained in this manual.
- Pay close attention to safety messages contained in this manual and on the motorcycle.

- The following codes in this manual indicate each country.
- The illustrations here in are based on the CB500XA ED type.

## Country Codes

Code	Country
<b>CB500X</b>	
E	UK
F	France, Belgium
ED	European direct sales
KO	Korea
<b>CB500XA</b>	
E	UK
F	France, Belgium
ED	European direct sales
U	Australia, New Zealand
KO	Korea

\*The specifications may vary with each locale.

## A Few Words About Safety

Your safety, and the safety of others, is very important. Operating this motorcycle safely is an important responsibility.

To help you make informed decisions about safety, we have provided operating procedures and other information on safety labels and in this manual. This information alerts you to potential hazards that could hurt you or others.

Of course, it is not practical or possible to warn you about all hazards associated with operating or maintaining a motorcycle. You must use your own good judgement.

You will find important safety information in a variety of forms, including:

- Safety labels on the motorcycle
- Safety Messages preceded by a safety alert symbol and one of three signal words: DANGER, WARNING, or CAUTION.

These signal words mean:

### **DANGER**

You **WILL** be **KILLED** or **SERIOUSLY HURT** if you don't follow instructions.

### **WARNING**

You **CAN** be **KILLED** or **SERIOUSLY HURT** if you don't follow instructions.

### **CAUTION**

You **CAN** be **HURT** if you don't follow instructions.

**Other important information is provided under the following titles:**

- NOTICE** Information to help you avoid damage to your motorcycle, other property, or the environment.

# Contents

**Motorcycle Safety** P. 2

**Operation Guide** P. 16

**Maintenance** P. 39

**Troubleshooting** P. 82

**Information** P. 102

**Specifications** P. 114

**Index** P. 117

# Motorcycle Safety

This section contains important information for safe riding of your motorcycle.  
Please read this section carefully.

<b>Safety Guidelines</b> .....	P. 3
<b>Image Labels</b> .....	P. 6
<b>Safety Precautions</b> .....	P. 10
<b>Riding Precautions</b> .....	P. 11
<b>Accessories &amp; Modifications</b> .....	P. 14
<b>Loading</b> .....	P. 15

## Safety Guidelines

Follow these guidelines to enhance your safety:

- Perform all routine and regular inspections specified in this manual.
- Stop the engine and keep sparks and flame away before filling the fuel tank.
- Do not run the engine in enclosed or partly enclosed areas. Carbon monoxide in exhaust gases is toxic and can kill you.

### Always Wear a Helmet

It's a proven fact: helmets and protective apparel significantly reduce the number and severity of head and other injuries. So always wear an approved motorcycle helmet and protective apparel. ➤ P. 10

### Before Riding

Make sure that you are physically fit, mentally focused and free of alcohol and drugs. Check

that you and your passenger are both wearing an approved motorcycle helmet and protective apparel. Instruct your passenger on holding onto the grab rails or your waist, leaning with you in turns, and keeping their feet on the footpegs, even when the motorcycle is stopped.

### Take Time to Learn & Practice

Even if you have ridden other motorcycles, practice riding in a safe area to become familiar with how this motorcycle works and handles, and to become accustomed to the motorcycle's size and weight.

### Ride Defensively

Always pay attention to other vehicles around you, and do not assume that other drivers see you. Be prepared to stop quickly or perform an evasive maneuver.

### Make Yourself Easy to See

Make yourself more visible, especially at night, by wearing bright reflective clothing, positioning yourself so other drivers can see you, signaling before turning or changing lanes, and using your horn when necessary.

### Ride within Your Limits

Never ride beyond your personal abilities or faster than conditions warrant. Fatigue and inattention can impair your ability to use good judgement and ride safely.

### Don't Drink and Ride

Alcohol and riding don't mix. Even one alcoholic drink can reduce your ability to respond to changing conditions, and your reaction time gets worse with every additional drink. Don't drink and ride, and don't let your friends drink and ride either.

### Keep Your Honda in Safe Condition

It's important to keep your motorcycle properly maintained and in safe riding condition. Inspect your motorcycle before every ride and perform all recommended maintenance. Never exceed load limits (📄 P. 15), and do not modify your motorcycle or install accessories that would make your motorcycle unsafe (📄 P. 14).

### If You are Involved in a Crash

Personal safety is your first priority. If you or anyone else has been injured, take time to assess the severity of the injuries and whether it is safe to continue riding. Call for emergency assistance if needed. Also follow applicable laws and regulations if another person or vehicle is involved in the crash.

If you decide to continue riding, first evaluate the condition of your motorcycle. If the engine is still running, turn it off. Inspect for fluid leaks,

check the tightness of critical nuts and bolts, and check the handlebar, control levers, brakes, and wheels. Ride slowly and cautiously. Your motorcycle may have suffered damage that is not immediately apparent. Have your motorcycle thoroughly checked at a qualified service facility as soon as possible.

### Carbon Monoxide Hazard

Exhaust contains poisonous carbon monoxide, a colourless, odorless gas. Breathing carbon monoxide can cause loss of consciousness and may lead to death.

If you run the engine in confined or even partly enclosed area, the air you breathe could contain a dangerous amount of carbon monoxide. Never run your motorcycle inside a garage or other enclosure.

## **WARNING**

Carbon monoxide gas is toxic. Breathing it can cause unconsciousness and even kill you.

Avoid any areas or activities that expose you to carbon monoxide.



# Image Labels

### Except KO type

The following pages describe the label meanings. Some labels warn you of potential hazards that could cause serious injury. Others provide important safety information. Read this information carefully and don't remove the labels.

If a label comes off or becomes hard to read, contact your dealer for a replacement.

There is a specific symbol on each label. The meanings of each symbol and label are as follows.



Read instructions contained in Owner's Manual carefully.



Read instructions contained in Shop Manual carefully. In the interest of safety, take the motorcycle to be serviced only by your dealer.



### **DANGER (with RED background)**

You **WILL** be **KILLED** or **SERIOUSLY HURT** if you don't follow instructions.

### **WARNING (with ORANGE background)**

You **CAN** be **KILLED** or **SERIOUSLY HURT** if you don't follow instructions.

### **CAUTION (with YELLOW background)**

You **CAN** be **HURT** if you don't follow instructions.



## **BATTERY LABEL DANGER**

- Keep flame and spark away from the battery. Battery produce explosive gas that can cause explosion.
- Wear the eye protection and rubber gloves when handling the battery, or you can get burned or lose your eyesight by the battery electrolyte.
- Do not allow children and other people to touch a battery unless they understand proper handling and hazards of the battery very well.
- Handle the battery electrolyte with extreme care as it contains dilute sulfuric acid. Contact with your skin or eyes can burn you or cause loss of your eyesight.
- Read this manual carefully and understand it before handling the battery. Neglect of the instructions can cause personal injury and damage to the motorcycle.
- Do not use a battery with the electrolyte at or below the lower level mark. It can explode causing serious injury.



### RADIATOR CAP LABEL

Except U type

#### DANGER

NEVER OPEN WHEN HOT.

Hot coolant will scald you.

Relief pressure valve begins to open at **1.1 kgf/cm<sup>2</sup>**.

### ACCESSORIES AND LOADING WARNING LABEL

Except U type

#### WARNING

##### ACCESSORIES AND LOADING

- The safety stability and handling of this motorcycle may be affected by the addition of accessories and luggage.
- Read carefully the instructions contained in user's manual and installation guide before installing any accessory.
- The total weight of accessories and luggage added to rider's and passenger's weight should not exceed **185 kg (408 lb)**, which is the maximum weight capacity.
- The luggage weight must not exceed **11 kg (24 lb)** under any circumstances.
- The fitting of large fork-mounted or large handlebar mounted fairing is not recommended.



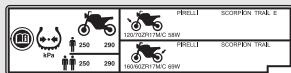

### TYRE INFORMATION LABEL

Cold tyre pressure:

[Driver only]

Front **250 kPa (2.50 kgf/cm<sup>2</sup>, 36 psi)**

Rear **290 kPa (2.90 kgf/cm<sup>2</sup>, 42 psi)**

[Driver and passenger]

Front **250 kPa (2.50 kgf/cm<sup>2</sup>, 36 psi)**

Rear **290 kPa (2.90 kgf/cm<sup>2</sup>, 42 psi)**

Tyre size:

Front **120/70ZR17M/C 58W**

Rear **160/60ZR17M/C 69W**

Tyre brand: PIRELLI

Front **SCORPION TRAIL E**

Rear **SCORPION TRAIL**



### SAFETY REMINDER LABEL

For your protection, always wear helmet, protective apparel.

### FUEL LABEL

Unleaded petrol only



### DRIVE CHAIN LABEL

Keep chain adjusted and lubricated.

**35 to 45 mm (1.4 to 1.8 in) Freeplay**

# Safety Precautions

- Ride cautiously and keep your hands on the handlebar and feet on the footpegs.
- Keep passenger's hands onto the grab rails or your waist, passenger's feet on the footpegs while riding.
- Always consider the safety of your passenger, as well as other drivers and riders.

## Protective Apparel

Make sure that you and any passenger are wearing an approved motorcycle helmet, eye protection, and high-visibility protective clothing. Ride defensively in response to weather and road conditions.

### ■ Helmet

Safety-standard certified, high-visibility, correct size for your head

- Must fit comfortably but securely, with the chin strap fastened

- Face shield with unobstructed field of vision or other approved eye protection

## **⚠ WARNING**

Not wearing a helmet increases the chance of serious injury or death in a crash.

Make sure that you and any passenger always wear an approved helmet and protective apparel.

### ■ Gloves

Full-finger leather gloves with high abrasion resistance

### ■ Boots or Riding Shoes

Sturdy boots with non-slip soles and ankle protection

### ■ Jacket and Trousers

Protective, highly visible, long-sleeved jacket and durable trousers for riding (or a protective suit).

## Riding Precautions

### Running-in Period

During the first 500 km (300 miles) of running, follow these guidelines to ensure your motorcycle's future reliability and performance.

- Avoid full-throttle starts and rapid acceleration.
- Avoid hard braking and rapid down-shifts.
- Ride conservatively.

### Brakes

Observe the following guidelines:

- For full braking effectiveness, operate both the front and rear brakes together.
- Avoid excessively hard braking and down-shifts.
  - ▶ Sudden braking can reduce the motorcycle's stability.
  - ▶ Where possible, reduce speed before turning; otherwise you risk sliding out.
- Exercise caution on low traction surfaces.
  - ▶ The tyres slip more easily on such surfaces and braking distances are longer.
- Avoid continuous braking.
  - ▶ Repeated braking, such as when descending long, steep slopes can seriously overheat the brakes, reducing their effectiveness. Use engine braking with intermittent use of the brakes to reduce speed.

### ■ Anti-lock Brake System (ABS)

CB500XA only

This model is equipped with an Anti-lock Brake System (ABS) designed to help prevent the brakes from locking up during hard braking.

- ABS does not reduce braking distance. In certain circumstances, ABS may result in a longer stopping distance.
- ABS does not function at speeds below 10 km/h (6 mph).
- The brake lever and pedal may recoil slightly when applying the brakes. This is normal.
- Always use the recommended tyres to ensure correct ABS operation.

### ■ Engine Braking

Engine braking helps slow your motorcycle down when you release the throttle. For further slowing action, downshift to a lower gear. Use engine braking with intermittent use of the brakes to reduce speed when descending long, steep slopes.

### ■ Wet or Rainy Conditions

Road surfaces are slippery when wet, and wet brakes further reduce braking efficiency. Exercise extra caution when braking in wet conditions.

If the brakes get wet, apply the brakes while riding at low speed to help them dry.

## Parking

- Park on a firm, level paved surface.
- If you must park on a slight incline or loose surface, park so that the motorcycle cannot move or fall over.
- Make sure that high-temperature parts cannot come into contact with flammable materials.
- Do not touch the engine, muffler, brakes and other high-temperature parts until they cool down.
- To reduce the likelihood of theft, always lock the handlebar and remove the key when leaving the motorcycle unattended. Use of an anti-theft device is also recommended.

### ■ Parking with the Side Stand

1. Stop the engine.
2. Push the side stand down.

3. Slowly lean the motorcycle to the left until its weight rests on the side stand.
4. Turn the handlebar fully to the left.
  - ▶ Turning the handlebar to the right reduces stability and may cause the motorcycle to fall.
5. Turn the ignition switch to the LOCK position and remove the key. 📄 P. 33

## Refuelling and Fuel Guidelines

Follow these guidelines to protect the engine and catalytic converter:

- Use only unleaded petrol.
- Use recommended octane number. Using lower octane petrol will result in decreased engine performance.
- Do not use fuels containing a high concentration of alcohol. 📄 P. 106
- Do not use stale or contaminated petrol or an oil/petrol mixture.
- Avoid getting dirt or water in the fuel tank.



## Accessories & Modifications

We strongly advise that you do not add any accessories that were not specifically designed for your motorcycle by Honda or make modifications to your motorcycle from its original design. Doing so can make it unsafe. Modifying your motorcycle may also void your warranty and make your motorcycle illegal to operate on public roads and highways. Before deciding to install accessories on your motorcycle be certain the modification is safe and legal.

### **WARNING**

Improper accessories or modifications can cause a crash in which you can be seriously hurt or killed.

**Follow all instructions in this owner's manual regarding accessories and modifications.**

Do not pull a trailer with, or attach a sidecar to, your motorcycle. Your motorcycle was not designed for these attachments, and their use can seriously impair your motorcycle's handling.

## Loading

- Carrying extra weight affects your motorcycle's handling, braking and stability. Always ride at a safe speed for the load you are carrying.
- Avoid carrying an excessive load and keep within specified load limits.  
**☒ Maximum weight capacity / Maximum luggage weight P. 114**
- Tie all luggage securely, evenly balanced and close to the centre of the motorcycle.
- Do not place objects near the lights or the muffler.

### **WARNING**

Overloading or improper loading can cause a crash and you can be seriously hurt or killed.

Follow all load limits and other loading guidelines in this manual.

# Parts Location

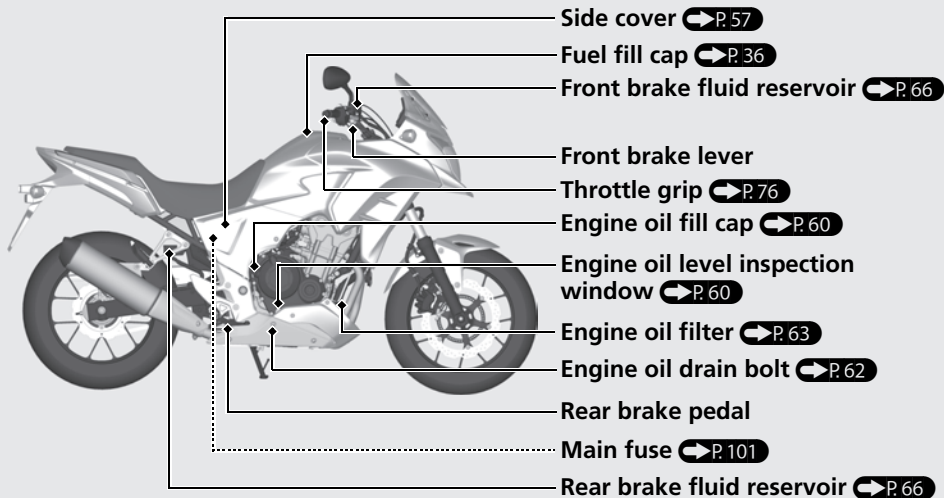

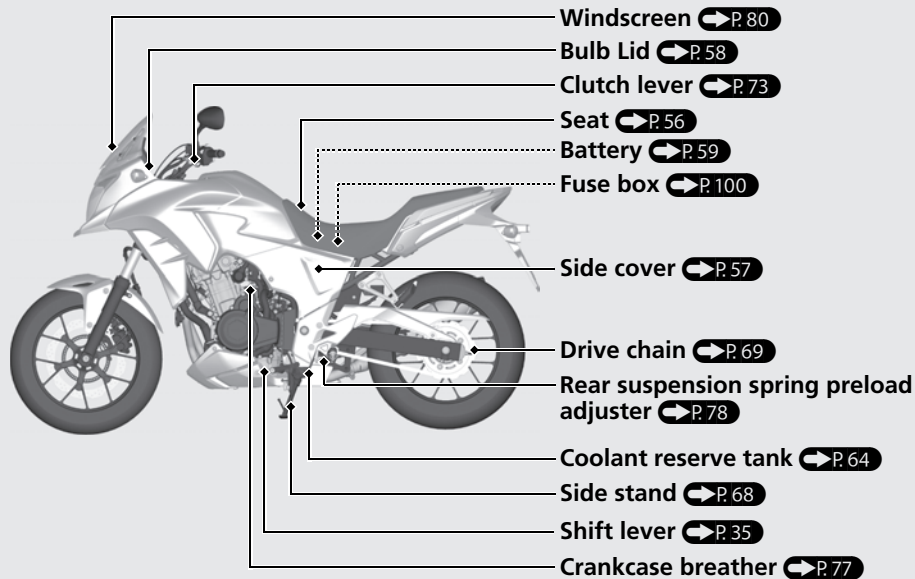

# Instruments

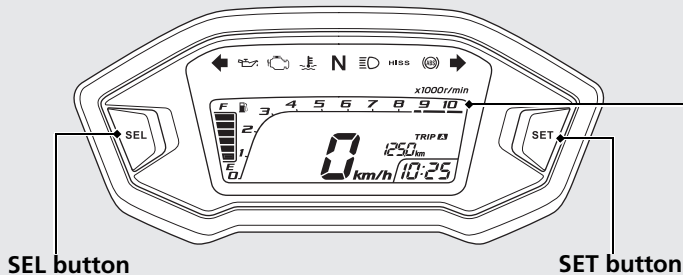

## Display Check

When the ignition switch is turned on, all the mode and digital segments will show, and the tachometer segment progresses to maximum scale and then disappears.

If any part of these displays does not come on when it should, have your dealer check for problems.

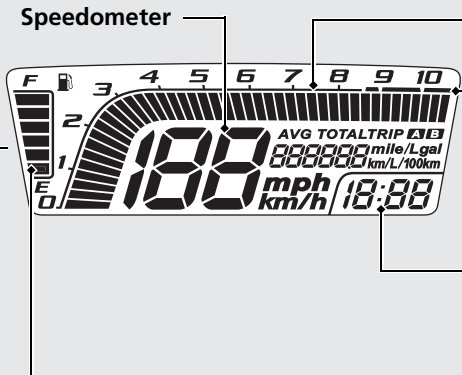

**Speedometer**

**Tachometer**

**NOTICE**

Do not operate the engine in the tachometer red zone. Excessive engine speed can adversely affect engine life.

**Tachometer red zone**  
(excessive engine rpm range)

**Clock (12-hour display)**  
To set the clock: ➔ P.25

**Fuel gauge**

Remaining fuel when only 1st (E) segment starts flashing:  
approximately 2.8 litres (0.74 US gal, 0.62 Imp gal)



**If the fuel gauge indicators repeat flashing or turned off:** ➔ P.87

## Instruments (Continued)

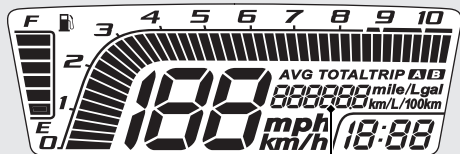

### Odometer [TOTAL] & Tripmeter [TRIP A/B] & Fuel mileage meter & Fuel consumption meter

SEL button selects the odometer, tripmeter A, tripmeter B, current fuel mileage, average fuel mileage and fuel consumption.

▶ To reset the tripmeter:  P.22

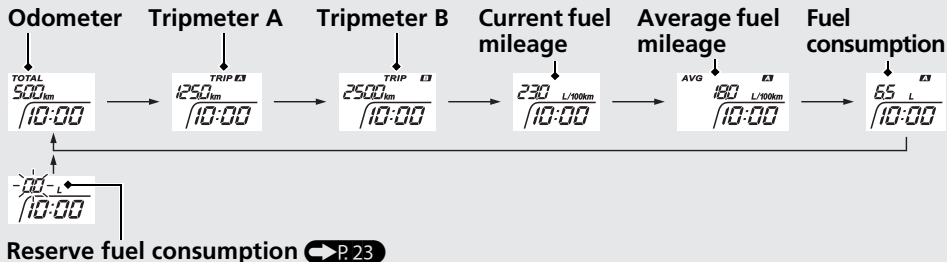

The average fuel mileage and fuel consumption will be based on tripmeter A.

- Current fuel mileage:  
Current instant fuel mileage. If your speed is less than 7 km/h (5 mph), " --- " is displayed. When " --.- " is displayed at speeds above 7 km/h (5 mph), go to your dealer for service.
- Average fuel mileage:  
Average fuel mileage since tripmeter A was reset. When " --.- " is displayed, go to your dealer for service.
- Fuel consumption:  
Total fuel consumption since tripmeter A was reset. When " ---.- " displayed, go to your dealer for service.

► **To reset the average fuel mileage and fuel consumption:**  **P.22**



## Instruments *(Continued)*

### To reset the tripmeter, average fuel mileage and fuel consumption

- 1 To reset tripmeter A, average fuel mileage, and fuel consumption together, press and hold SET button with tripmeter A, average fuel mileage, or fuel consumption displayed.

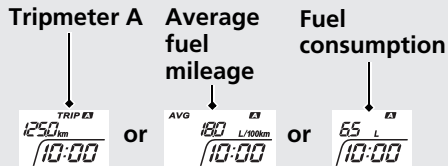

- 2 When they are reset, "0.0" is displayed at each indication.



- 3 Then, the display returns to the last selected indication.



- 4 To reset tripmeter B, press and hold SET button with tripmeter B displayed.

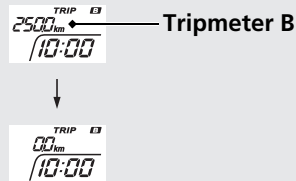

Also, the tripmeter A, average fuel mileage, and fuel consumption will automatically reset by refuelling more than the reserve amount and riding your motorcycle for 0.1 km (0.06 mile).

You can activate or deactivate the automatic reset mode by refuelling. ➔ P.27

### Reserve fuel consumption display

When the 1st (E) segment of the fuel gauge starts flashing, the odometer & tripmeter & fuel mileage meter & fuel consumption meter switches to the reserve fuel consumption. You should refill the tank as soon as possible.

#### Reserve fuel consumption display

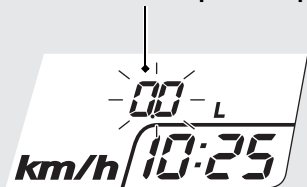

- Flashes from "0.0" L (litre) or gal (US gal).
  - ▶ When the amount of consumed fuel is more than 1.0 litre (0.26 US gal, 0.22 Imp gal) the display blinks faster.
  - ▶ If you change the display to odometer, tripmeter, fuel mileage meter and fuel consumption meter and so on  P. 20, it will automatically return to the reserve fuel consumption display if the buttons are not pressed after for about 10 seconds.

## Instruments *(Continued)*

### Display Setting

Following items to change sequentially.

- Clock setting
- Backlight brightness adjustment
- Activating/deactivating of tripmeter A, average fuel mileage and fuel consumption automatic reset mode
- Setting of HISS indicator
- **E type only** Changing of speed and mileage unit
- Changing of fuel mileage meter unit

➡ Press and hold SEL button and SET button

⇨ Press SET button

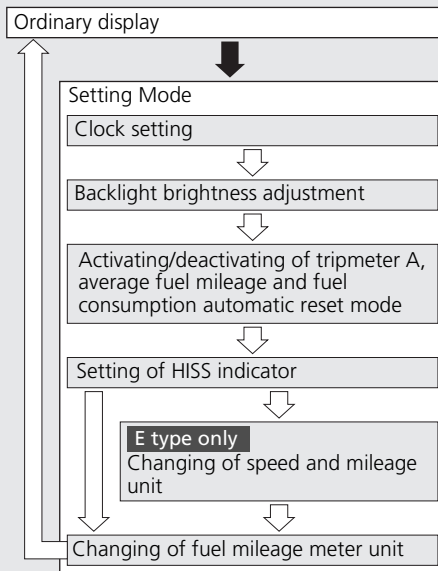

In addition, to return to the ordinary display at display setting.

- The button is not pressed for about 30 seconds
- Turn the ignition switch off and then on

### 1 To set the clock:

- 1 Turn the ignition switch to ON.
- 2 Press and hold SEL button and SET button, the hour digits start flashing.
- 3 Press SEL button until the desired hour is displayed.
  - ▶ Press and hold to advance the hour fast.



- 4 Press SET button. The minute digits start flashing.



- 5 Press SEL button until the desired minute is displayed.
  - ▶ Press and hold to advance the minute fast.

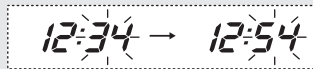

- 6 Press SET button. The clock is set, and then the display moves to the backlight brightness adjustment.

## Instruments *(Continued)*

### 2 Backlight brightness adjustment:

You can adjust the brightness to five levels.

- 1 Press SEL button. The brightness is switched.

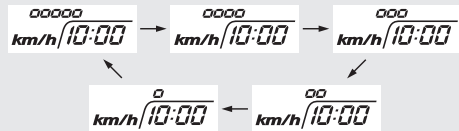

- 2 Press SET button. The backlight is set, and then the display moves to activating/deactivating of tripmeter A, average fuel mileage and fuel consumption automatic reset mode.

### 3 To activate/deactivate of tripmeter A, average fuel mileage and fuel consumption automatic reset mode:

You can also activate or deactivate the automatic reset mode by refuelling after 1st (E) segment of the fuel gauge starts flashing. Deactivation is initially set.

- 1 Press SEL button to select "On" (activate) or "OFF" (deactivate) in the automatic reset mode.

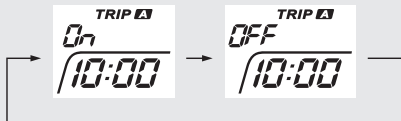

- 2 To end the selection, press SET button. The activation/deactivation of automatic reset mode is set, and then the display moves to the on/off of blinks of HISS indicator (HISS indicator comes on).

#### 4 HISS indicator setting:

You can select the blink or off the HISS indicator.

- 1 Press SEL button to select "On" (blinks) or "OFF" (off).

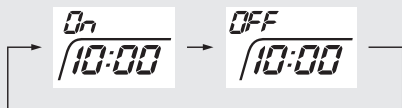

- 2 **Except E type**

Press SET button. The HISS indicator setting is set, and then the display moves to the changing of the fuel mileage meter unit.

##### **E type only**

Press SET button. The HISS indicator setting is set, and then the display moves to the changing of the speed and mileage unit.

#### 5 Changing the speed and mileage unit:

##### **E type only**

- 1 Press SEL button to select either "km/h" and "km" or "mph" and "mile."

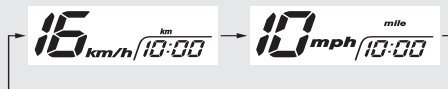

- 2 Press SET button. The speed and mileage unit is set, and then the display moves to the changing of the fuel mileage meter unit.

## 6 Changing the fuel mileage meter unit:

- 1 Press SEL button to select "km/L" or "L/100 km."

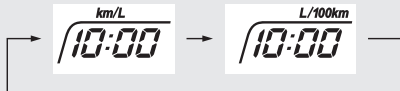

### E type only

If the "mph" for speed and "mile" for mileage are selected, the fuel mileage shown by "mile/L" or "mile/gal."

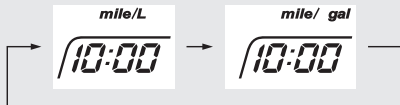

- 2 To end the selection, press SET button.

The established setting can also be set by turning the ignition switch to OFF.

The control is automatically switched from the setting mode to the ordinary display if the button is not pressed for about 30 seconds. Even in this case, established setting is maintained.



# Indicators



## Low oil pressure indicator

Comes on when the ignition switch is turned on.  
Goes off when the engine starts.

**If it comes on while engine is running:** ➔ P. 85



## ABS (Anti-lock Brake System) indicator

CB500XA only

Comes on when the ignition switch is turned on.  
Goes off when your speed reaches approximately 10 km/h (6 mph).

**If it comes on while riding:** ➔ P. 86

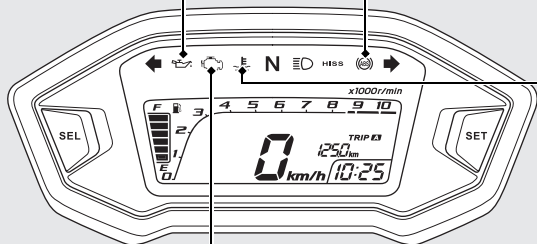

## High coolant temperature indicator



Comes on briefly when the ignition switch is turned on.

**If it comes on while riding:**

➔ P. 84



## PGM-FI (Programmed Fuel Injection) malfunction indicator lamp (MIL)

Comes on briefly when the ignition switch is turned on with the engine stop switch in the  (Run) position. Comes on when the ignition switch is turned on with the engine stop switch in the  (Off) position.

**If it comes on while engine is running:** ➔ P. 85

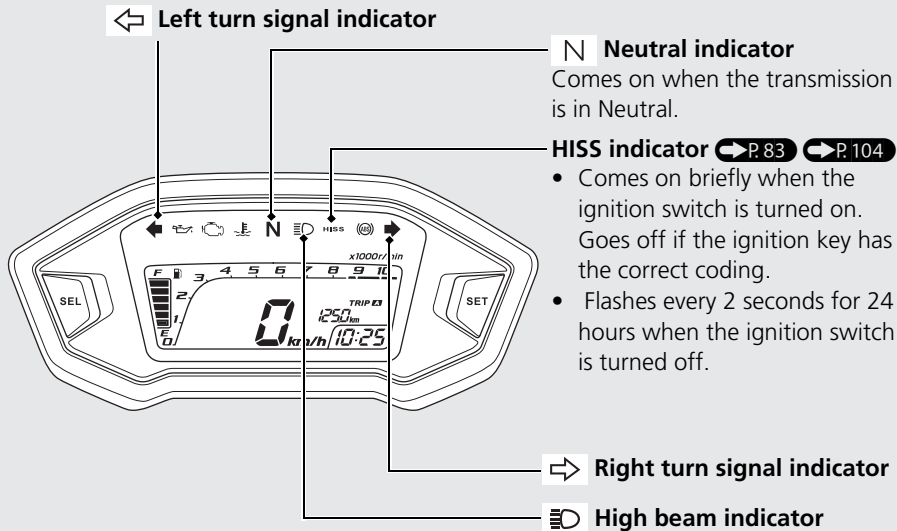

### N Neutral indicator

Comes on when the transmission is in Neutral.

### HISS indicator P.83 P.104

- Comes on briefly when the ignition switch is turned on. Goes off if the ignition key has the correct coding.
- Flashes every 2 seconds for 24 hours when the ignition switch is turned off.

### Right turn signal indicator

### High beam indicator

# Switches

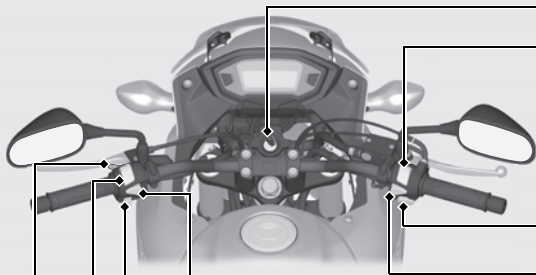



**Horn button**



**Turn signal switch**

- ▶ Pressing the switch turns the turn signal off.

**Headlight dimmer switch**

-  : High beam
-  : Low beam



**PASS Passing light control switch**

Flashes the high beam headlight.

**Engine stop switch**

Should normally remain in the  (Run) position.

- ▶ In an emergency, switch to the  (Off) position to stop the engine.



**Start button**



**Hazard switch**

Switchable when the ignition switch is on. Can be turned to off regardless of the ignition switch position.

- ▶ The signals continue flashing with the ignition switch is OFF or LOCK after the hazard switch is on.

## Ignition Switch

Switches the electrical system on/off, locks the steering.

- ▶ Key can be removed when in the OFF or LOCK position.

## Steering Lock

Lock the steering when parking to help prevent theft.

A U-shaped wheel lock or similar device is also recommended.

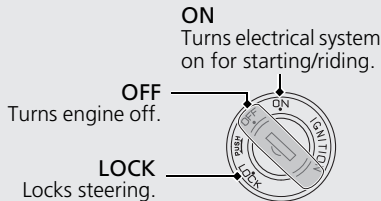
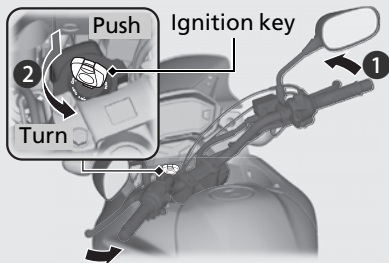

## Locking

- 1 Turn the handlebar all the way to the left.
- 2 Push the key down, and turn the ignition switch to the LOCK position.
  - ▶ Jiggle the handlebar if the lock is difficult to engage.
- 3 Remove the key.

## Unlocking

Insert the key, push it in, and turn the ignition switch to the OFF position.

# Starting the Engine

Start your engine using the following procedure, regardless of whether the engine is cold or warm.

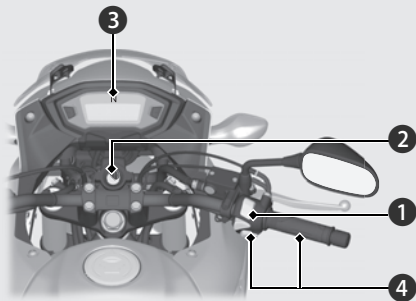

## NOTICE

- If the engine does not start within 5 seconds, turn the ignition off and wait 10 seconds before trying to start the engine again to recover battery voltage.
- Extended fast idling and revving the engine can damage the engine, and the exhaust system.
- Snapping the throttle or fast idling for more than about 5 minutes may cause exhaust pipe discolouration.

- 1 Make sure the engine stop switch is in the  (Run) position.
- 2 Turn the ignition switch to the ON position.
- 3 Shift the transmission to Neutral (**N** indicator comes on). Alternatively, pull in the clutch lever to start your motorcycle with the transmission in gear so long as the side stand is raised.
- 4 Press the start button with the throttle completely closed.

If the engine does not start:

- 1 Open the throttle fully and press the start button for 5 seconds.
- 2 Repeat the normal starting procedure.
- 3 If the engine starts, open the throttle slightly if idling is unstable.
- 4 If the engine does not start, wait 10 seconds before trying steps 1 & 2 again.

**If Engine Will Not Start**  P.83

# Shifting Gears

Your motorcycle transmission has six forward gears in a one-down, five-up shift pattern.

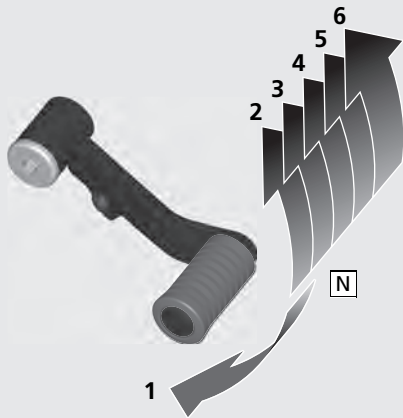

If you put the motorcycle in gear with the side stand down, the engine will shut off.

# Refuelling

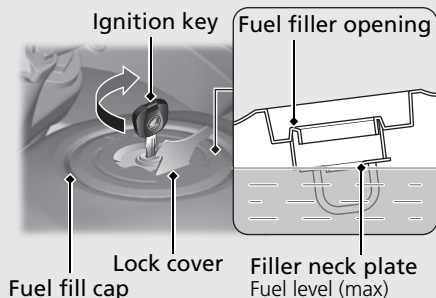

Do not fill with fuel above the plate.

**Fuel type:** Unleaded petrol only

**Fuel octane number:** Your motorcycle is designed to use Research Octane Number (RON) 91 or higher.

**Tank capacity:**

**Except KO type** 17.3 litres (4.57 US gal, 3.81 Imp gal)

**KO type** 17.0 litres (4.49 US gal, 3.74 Imp gal)

**Refuelling and Fuel Guidelines** ➔ P.13

## Opening the Fuel Fill Cap

Open the lock cover, insert the ignition key, and turn it clockwise to remove the cap.

## Closing the Fuel Fill Cap

- 1 After refuelling, align the fuel fill cap latch with the slot in the filler neck.
- 2 Push the fuel fill cap into the filler neck until it snaps closed and locks.
- 3 Remove the key and close the lock cover.
  - ▶ The key cannot be removed if the cap is not locked.

## ⚠ WARNING

Petrol is highly flammable and explosive. You can be burned or seriously injured when handling fuel.

- Stop the engine, and keep heat, sparks, and flame away.
- Handle fuel only outdoors.
- Wipe up spills immediately.

# Storage Equipment

## Helmet holder

The helmet holder is located under the seat.  
A helmet set wire is in the tool kit.

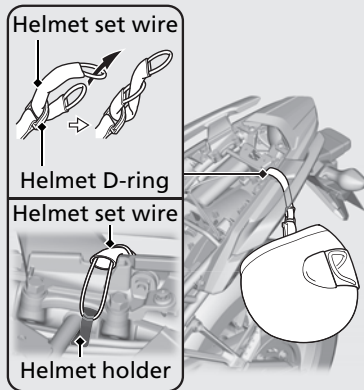

► Use the helmet holder only when parked.

▮ **Removing the Seat.** ➡ P.56

## **⚠ WARNING**

Riding with a helmet attached to the holder can interfere with the rear wheel or suspension and could cause a crash in which you can be seriously hurt or killed.

Use the helmet holder only while parked. Do not ride with a helmet secured by the holder.



## Tool kit / U-shaped lock

The tool kit is located under the seat.  
There is also space to store a U-shaped lock.

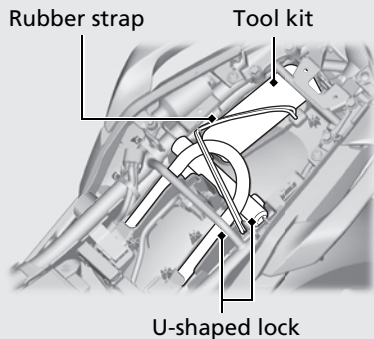

- ▶ The U-shaped lock is held in place under the seat.
- ▶ Some U-shaped locks may not fit in the compartment due to their size or design.

## Document bag

The document bag is located underside of the seat.

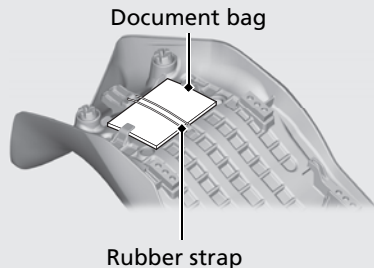

**Removing the Seat.** ➔ P. 56

# Maintenance

Please read "Importance of Maintenance" and "Maintenance Fundamentals" carefully before attempting any maintenance. Refer to "Specifications" for service data.

<b>Importance of Maintenance</b> .....	P. 40	<b>Brakes</b> .....	P. 66
<b>Maintenance Schedule</b> .....	P. 41	<b>Side Stand</b> .....	P. 68
<b>Maintenance Fundamentals</b> .....	P. 44	<b>Drive Chain</b> .....	P. 69
<b>Tool Kit</b> .....	P. 55	<b>Clutch</b> .....	P. 73
<b>Removing &amp; Installing Body Components</b> ....	P. 56	<b>Throttle</b> .....	P. 76
Seat .....	P. 56	<b>Crankcase Breather</b> .....	P. 77
Side Cover .....	P. 57	<b>Other Adjustments</b> .....	P. 78
Bulb Lid .....	P. 58	Rear Suspension .....	P. 78
Clip.....	P. 58	Headlight Aim .....	P. 79
Battery.....	P. 59	Brakelight Switch .....	P. 79
<b>Engine Oil</b> .....	P. 60	Windscreen Height.....	P. 80
<b>Coolant</b> .....	P. 64		

# Importance of Maintenance

## Importance of Maintenance

Keeping your motorcycle well-maintained is absolutely essential to your safety and to protect your investment, obtain maximum performance, avoid breakdowns, and reduce air pollution. Maintenance is the owner's responsibility. Be sure to inspect your motorcycle before each ride, and perform the periodic checks specified in the Maintenance Schedule. ➤ P. 41

### **WARNING**

Improperly maintaining your motorcycle or failing to correct a problem before you ride can cause a crash in which you can be seriously hurt or killed.

Always follow the inspection and maintenance recommendations and schedules in this owner's manual.

## Maintenance Safety

Always read the maintenance instructions before you begin each task, and make sure that you have the tools, parts, and skills required. We cannot warn you of every conceivable hazard that can arise in performing maintenance. Only you can decide whether or not you should perform a given task.

Follow these guidelines when performing maintenance.

- Stop the engine and remove the key.
- Park your motorcycle on a firm, level surface using the side stand or a maintenance stand to provide support.
- Allow the engine, muffler, brakes, and other high-temperature parts to cool before servicing as you can get burned.
- Run the engine only when instructed, and do so in a well-ventilated area.

## Maintenance Schedule









The maintenance schedule specifies the maintenance requirements necessary to ensure safe, dependable performance, and proper emission control.

Maintenance work should be performed in accordance with Honda's standards and specifications by properly trained and equipped technicians. Your dealer meets all of these requirements. Keep an accurate record of maintenance to help ensure that your motorcycle is properly maintained. Make sure that whomever performs the maintenance completes this record.



All scheduled maintenance is considered a normal owner operating cost and will be charged for by your dealer. Retain all receipts. If you sell the motorcycle, these receipts should be transferred with the motorcycle to the new owner.

Honda recommends that your dealer should road test your motorcycle after each periodic maintenance is carried out.

## Maintenance Schedule





Items	Pre-ride Check P. 44	Frequency *1						Annual Check	Regular Replace	Refer to page
		x 1,000 km	1	12	24	36	48			
		x 1,000 mi	0.6	8	16	24	32			
Fuel Line				I	I	I	I	I		-
Fuel Level		I								36
Throttle Operation		I		I	I	I	I	I		76
Air Cleaner *2					R		R			54
Crankcase Breather *3				C	C	C	C	C		77
Spark Plug					R		R			-
Valve Clearance			I		I		I			-
Engine Oil		I	R	R	R	R	R	R		62
Engine Oil Filter			R	R	R	R	R	R		63
Engine Idle Speed			I	I	I	I	I	I		-
Radiator Coolant *4		I		I	I	I	I	I	3 Years	64
Cooling System				I	I	I	I	I		-
Secondary Air Supply System				I	I	I	I	I		-

### Maintenance Level

-  : Intermediate. We recommend service by your dealer, unless you have the necessary tools and are mechanically skilled. Procedures are provided in an official Honda Shop Manual.
-  : Technical. In the interest of safety, have your motorcycle serviced by your dealer.

### Maintenance Legend

- I** : Inspect (clean, adjust, lubricate, or replace if necessary)
- L** : Lubricate
- R** : Replace
- C** : Clean

Items	Pre-ride Check P. 44	Frequency *1					Annual Check	Regular Replace	Refer to page	
		x 1,000 km	1	12	24	36				48
		x 1,000 mi	0.6	8	16	24				32
Drive Chain	I		Every 1,000 km (600 mi): I L							69
Drive Chain Slider				I	I	I	I			72
Brake Fluid *4	I			I	I	I	I	I	2 Years	66
Brake Pads Wear	I			I	I	I	I	I		67
Brake System			I	I	I	I	I	I		66
Brakelight Switch				I	I	I	I	I		79
Headlight Aim				I	I	I	I	I		79
Lights/Horn	I									-
Engine Stop Switch	I									-
Clutch System	I		I	I	I	I	I	I		73
Side Stand	I			I	I	I	I	I		68
Suspension				I	I	I	I	I		-
Nuts, Bolts, Fasteners			I	I	I	I	I	I		-
Wheels/Tyres		I		I	I	I	I	I		51
Steering Head Bearings			I	I	I	I	I	I		-

**Notes:**

- \*1 : At higher odometer readings, repeat at the frequency interval established here.
- \*2 : Service more frequently when riding in unusually wet or dusty areas.
- \*3 : Service more frequently when riding in rain or at full throttle.
- \*4 : Replacement requires mechanical skill.

## Pre-ride Inspection

To ensure safety, it is your responsibility to perform a pre-ride inspection and make sure that any problem you find is corrected. A pre-ride inspection is a must, not only for safety, but because having a breakdown, or even a flat tyre, can be a major inconvenience.

Check the following items before you ride motorcycle:

- Fuel level – Fill fuel tank when necessary. ➤ P. 36
- Throttle – Check for smooth opening and full closing in all steering positions. ➤ P. 76
- Engine oil level – Add engine oil if necessary. Check for leaks. ➤ P. 60
- Coolant level – Add coolant if required. Check for leaks. ➤ P. 64

- Drive chain – Check condition and slack, adjust and lubricate if necessary. ➤ P. 69
- Brakes – Check operation;  
Front and Rear: check brake fluid level and pads wear. ➤ P. 66, 67
- Lights and horn – Check that lights, indicators and horn function properly.
- Engine stop switch – Check for proper function.
- Clutch – Check operation;  
Adjust freeplay if necessary. ➤ P. 73
- Side stand ignition cut-off system – Check for proper function. ➤ P. 68
- Wheels and tyres – Check condition, air pressure and adjust if necessary. ➤ P. 51

## Replacing Parts

Always use Honda Genuine Parts or their equivalents to ensure reliability and safety.

When ordering coloured components, specify the model name, colour, and code mentioned on the colour label. The colour label is attached to the rear fender under the seat. ➤ P. 56

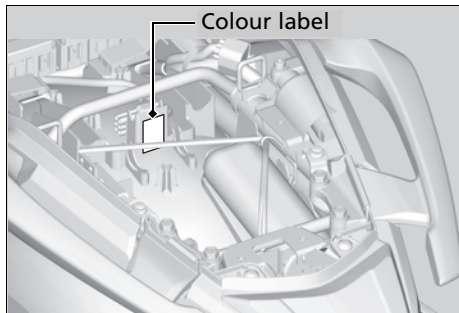

### **⚠ WARNING**

Installing non-Honda parts may make your motorcycle unsafe and cause a crash in which you can be seriously hurt or killed.

Always use Honda Genuine Parts or equivalents that have been designed and approved for your motorcycle.



### Battery

Your motorcycle has a maintenance-free type battery. You do not have to check the battery electrolyte level or add distilled water. Clean the battery terminals if they become dirty or corroded.

Do not remove the battery cap seals. There is no need to remove the cap when charging.

#### NOTICE

Your battery is a maintenance-free type and can be permanently damaged if the cap strip is removed.



This symbol on the battery means that this product must not be treated as household waste.

#### NOTICE

An improperly disposed of battery can be harmful to the environment and human health.

Always confirm local regulations for battery disposal.

### **⚠️ WARNING**

The battery gives off explosive hydrogen gas during normal operation.

A spark or flame can cause the battery to explode with enough force to kill or seriously hurt you.

Wear protective clothing and a face shield, or have a skilled mechanic do the battery servicing.

#### **▮ Cleaning the Battery Terminals**

1. Remove the battery. P. 59
2. If the terminals are starting to corrode and are coated with a white substance, wash with warm water and wipe clean.

3. If the terminals are heavily corroded, clean and polish the terminals with a wire brush or sandpaper. Wear safety glasses.

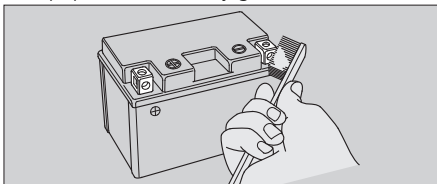

4. After cleaning, reinstall the battery.

The battery has a limited life span. Consult your dealer about when you should replace the battery. Always replace the battery with another maintenance-free battery of the same type.

#### NOTICE

Installing non-Honda electrical accessories can overload the electrical system, discharging the battery and possibly damaging the system.

## Fuses

Fuses protect the electrical circuits on your motorcycle. If something electrical on your motorcycle stops working, check for and replace any blown fuses. 📄 P. 100

### Inspecting and Replacing Fuses

Turn off the ignition switch to remove and inspect fuses. If a fuse is blown, replace with a fuse of the same rating. For fuse ratings, see “Specifications.” 📄 P. 116

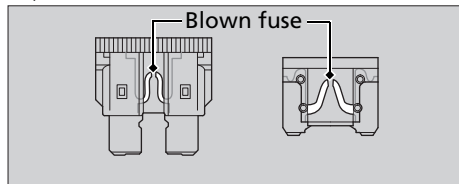

#### NOTICE

Replacing a fuse with one that has a higher rating greatly increases the chance of damage to the electrical system.

If a fuse fails repeatedly, you likely have an electrical fault. Have your motorcycle inspected by your dealer.

### Engine Oil

Engine oil consumption varies and oil quality deteriorates according to riding conditions and time elapsed.

Check the engine oil level regularly, and add the recommended engine oil if necessary. Dirty oil or old oil should be changed as soon as possible.

#### Selecting the Engine Oil

For recommended engine oil, see “Specifications.” P. 115

If you use non-Honda engine oil, check the label to make sure that the oil satisfies all of the following standards:

- JASO T 903 standard\*<sup>1</sup>: MA
- SAE standard\*<sup>2</sup>: 10W-30
- API classification\*<sup>3</sup>: SG or higher

- \*1. The JASO T 903 standard is an index for engine oils for 4-stroke motorcycle engines. There are two classes: MA and MB. For example, the following label shows the MA classification.

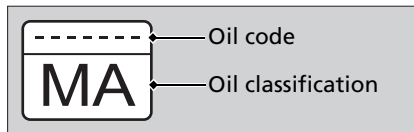

- \*2. The SAE standard grades oils by their viscosity.
- \*3. The API classification specifies the quality and performance rating of engine oils. Use SG or higher oils, excluding oils marked as “Energy Conserving” or “Resource Conserving” on the circular API service symbol.

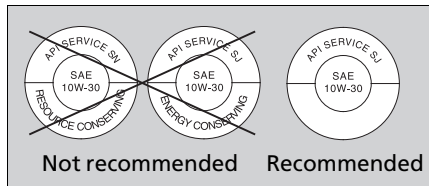

## Brake Fluid

Do not add or replace brake fluid, except in an emergency. Use only fresh brake fluid from a sealed container. If you do add fluid, have the brake system serviced by your dealer as soon as possible.

### NOTICE

Brake fluid can damage plastic and painted surfaces. Wipe up spills immediately and wash thoroughly.

### Recommended brake fluid:

Honda DOT 4 Brake Fluid or equivalent

## Drive Chain

The drive chain must be inspected and lubricated regularly. Inspect the chain more frequently if you often ride on bad roads, ride at high speed, or ride with repeated fast acceleration.

If the chain does not move smoothly, makes strange noises, has damaged rollers or loose pins or missing O-rings, or kinks, have the chain inspected by your dealer.

Also inspect the engine sprocket and rear wheel sprocket. If either has worn or damaged teeth, have the sprocket replaced by your dealer.

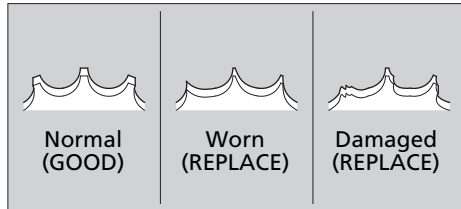

### NOTICE

Use of a new chain with worn sprockets will cause rapid chain wear.

### **I Cleaning and Lubricating**

After inspecting the slack, clean the chain and sprockets while rotating the rear wheel. Use dry cloth with chain cleaner designed specifically for O-ring chains, or neutral detergent. Use a soft brush if the chain is dirty.

After cleaning, wipe dry and lubricate with the recommended lubricant. If not available, use SAE 80 or 90 gear oil.

#### **Recommended lubricant:**

Drive chain lubricant designed specifically for O-ring chains.  
If not available, use SAE 80 or 90 gear oil.

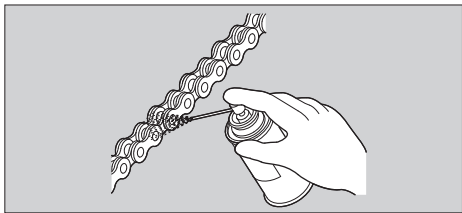

Do not use a steam cleaner, a high pressure cleaner, a wire brush, volatile solvent such as petrol and benzene, abrasive cleaner, chain cleaner or lubricant NOT designed specifically for O-ring chains as these can damage the rubber O-ring seals.

Avoid getting lubricant on the brakes or tyres. Avoid applying excess chain lubricant to prevent spray onto your clothes and the motorcycle.

#### **Recommended Coolant**

Pro Honda HP coolant is a pre-mixed solution of antifreeze and distilled water.

#### **Concentration:**

50% antifreeze and 50% distilled water

A concentration of antifreeze below 40% will not provide proper corrosion and cold temperature protection.

A concentration of up to 60% will provide better protection in colder climates.

#### NOTICE

Using coolant not specified for aluminium engines or ordinary tap water or mineral can cause corrosion.

### Crankcase Breather

Service more frequently when riding in rain, at full throttle, or after the motorcycle is washed or overturned. Service if the deposit level can be seen in the transparent section of the drain tube.

### Tyres (Inspecting/Replacing)

#### Checking the Air Pressure

Visually inspect your tyres and use an air pressure gauge to measure the air pressure at least once a month or any time you think the tyres look low. Always check air pressure when your tyres are cold.

#### Inspecting for Damage

Inspect the tyres for cuts, slits, or cracks that exposes fabric or cords, or nails or other foreign objects embedded in the side of the tyre or the tread. Also inspect for the bumps or bulges in the side walls of the tyres.

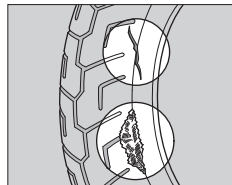

#### Inspecting for Abnormal Wear

Inspect the tyres for signs of abnormal wear on the contact surface.

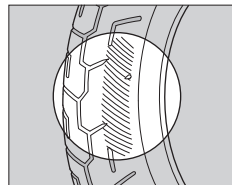

### Inspecting Tread Depth

Inspect the tread wear indicators. If they become visible, replace the tyres immediately. For safe riding, you should replace the tyres when the minimum tread depth is reached.

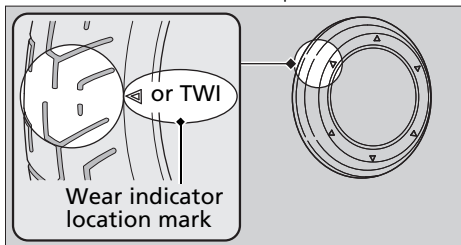

### **⚠ WARNING**

Riding on tyres that are excessively worn or improperly inflated can cause a crash in which you can be seriously hurt or killed.

Follow all instructions in this owner's manual regarding tyre inflation and maintenance.

#### Germany

German law prohibits use of tyres whose tread depth is less than 1.6 mm.

Have your tyres replaced by your dealer. For recommended tyres, air pressure and minimum tread depth, see “Specifications.”

➤ P. 115

Follow these guidelines whenever you replace tyres.

- Use the recommended tyres or equivalents of the same size, construction, speed rating, and load range.
- Have the wheel balanced with Honda Genuine balance weights or equivalents after the tyre is installed.
- Do not install a tube inside a tubeless tyre on this motorcycle. Excessive heat build-up can cause the tube to burst.
- Use only tubeless tyres on this motorcycle. The rims are designed for tubeless tyres, and during hard acceleration or braking, a tube-type tyre could slip on the rim and cause the tyre to rapidly deflate.

## **WARNING**

Installing improper tyres on your motorcycle can adversely affect handling and stability, and can cause a crash in which you can be seriously hurt or killed.

Always use the size and type of tyres recommended in this owner’s manual.



### Air Cleaner

This motorcycle is equipped with a viscous type air cleaner element.

Compressed air cleaning or any other cleaning can degrade the viscous element performance and cause the intake of dust.

Do not perform the maintenance.

Should be serviced by your dealer.

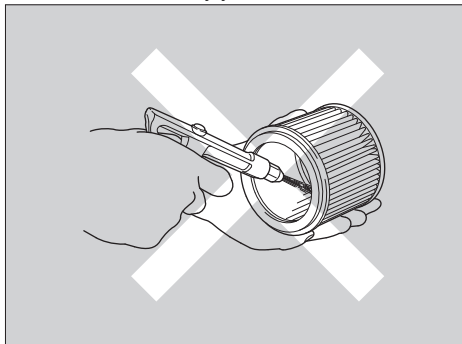

The tool kit is stored under the seat. ➔ P. 56

You can perform some roadside repairs, minor adjustments and parts replacement with the tools contained in the kit.

## E, F, ED type

- Pin spanner
- 10 × 14 mm Open end wrench
- Standard/Phillips screwdriver
- Screwdriver handle
- Extension bar
- 5 mm Hex wrench
- Helmet set wire
- Fuse puller

## U, KO type

- Pin spanner
- 8 × 12 mm Open end wrench
- 10 × 14 mm Open end wrench
- Standard/Phillips screwdriver
- Screwdriver handle
- Extension bar
- 5 mm Hex wrench
- 19 mm Box end wrench
- 24 mm Box end wrench
- Helmet set wire
- Fuse puller

## Seat

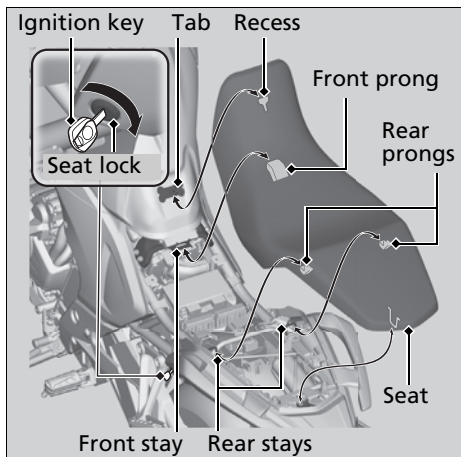

### Removal

1. Insert the ignition key into the seat lock.
2. Turn it clockwise, then pull the seat back and up.

### Installation

1. Insert the front and rear prongs into the front and rear stays on the frame.
  2. Insert the recess into the tab.
  3. Push forward and down on the rear of the seat until it locks in place.  
Make sure that the seat is locked securely in position to pull it up lightly.
- The seat locks automatically when closed. Take care not to lock your key in the compartment under the seat.

## Side Cover

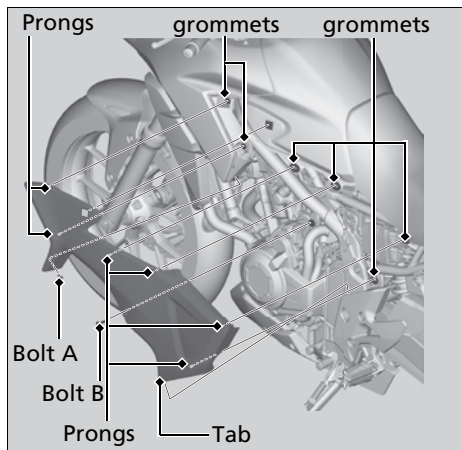

The left side cover must be removed to access the coolant reserve tank cap.  
The right side cover must be removed to access the main fuse.

The right and left side covers can be removed in the same manner.

### Removal

1. Remove the bolt A and bolt B.
2. Remove the prongs from the grommets.
3. Remove the side cover by releasing the tab.

### Installation

Install the parts in the reverse order of removal.

## Bulb Lid

The bulb lid must be removed to replace the headlight bulb and position light bulb.

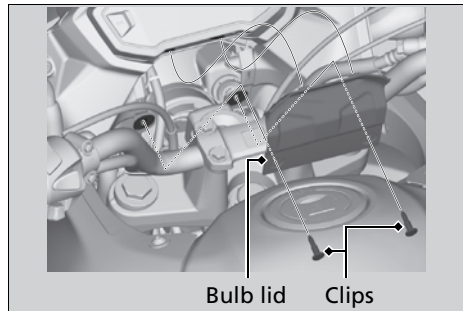

### Removal

1. Remove the clips and the bulb lid.

### Installation

1. Install the bulb lid and the clips.

## Clip

The clip must be removed to remove the bulb lid.

### Removal

1. Press down on the centre pin to release the lock.
2. Pull the clip out of the hole.

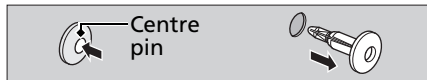

### Installation

1. Push the bottom of the centre pin.



2. Insert the clip into the hole.
3. Press down on the centre pin to lock the clip.

## Battery

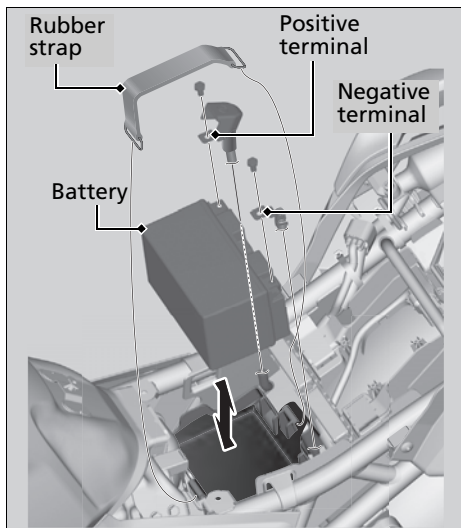

### Removal

Make sure the ignition switch is off.

1. Remove the seat. ► P. 56
2. Unhook the rubber strap from rear side.
3. Disconnect the negative  $\ominus$  terminal from the battery.
4. Disconnect the positive  $\oplus$  terminal from the battery.
5. Remove the battery taking care not to drop the terminal nuts.

### Installation

Install the parts in the reverse order of removal. Always connect the positive  $\oplus$  terminal first. Make sure that bolts and nuts are tight.

Readjust the clock after the battery is reconnected since the clock goes wrong once the battery disconnected.

The tripmeter A and B will be reset if the battery is disconnected.

For proper handling of the battery, see "Maintenance Fundamentals." ► P. 46  
 "Battery Goes Dead." ► P. 95

## Checking the Engine Oil

1. If the engine is cold, idle the engine for 3 to 5 minutes.
2. Turn the ignition switch off, stop the engine and wait for 2 to 3 minutes.
3. Place your motorcycle in an upright position on a firm, level surface.
4. Check that the oil level is between the upper and lower level marks in the oil inspection window.

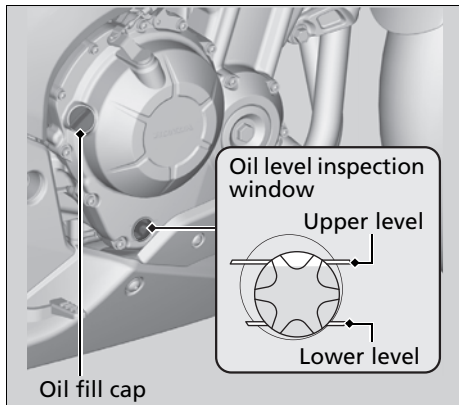

## Adding Engine Oil

---

If the engine oil is below or near the lower level mark, add the recommended engine oil.

► P. 48

1. Remove the oil fill cap. Add the recommended oil until it reaches the upper level mark.
  - Place your motorcycle in an upright position on a firm, level surface when checking the oil level.
  - Do not overfill above the upper level mark.
  - Make sure no foreign objects enter the oil filler opening.
  - Wipe up any spills immediately.
2. Securely reinstall the oil fill cap.

### NOTICE

Overfilling with oil or operating with insufficient oil can cause damage to your engine. Do not mix different brands and grades of oil. They may affect lubrication and clutch operation.

For the recommended oil and oil selection guidelines, see “Maintenance Fundamentals.” ► P. 48



## Changing Engine Oil & Filter

Changing the oil and filter requires special tools. We recommend that you have your motorcycle serviced by your dealer.

Use a new Honda Genuine oil filter or equivalent specified for your model.

### NOTICE

Using the wrong oil filter can result in serious damage to the engine.

1. If the engine is cold, idle the engine for 3 to 5 minutes.
2. Turn the ignition switch off, stop the engine and wait for 2 to 3 minutes.
3. Park on a firm, level surface and lower the side stand.
4. Place a drain pan under the drain bolt.

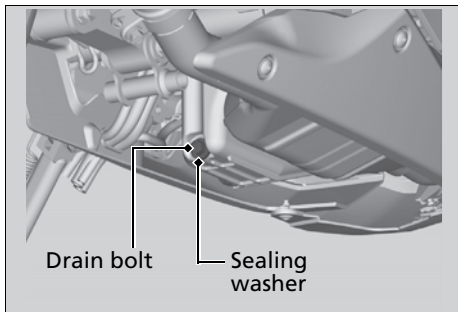

5. Remove the oil fill cap, drain bolt, and sealing washer to drain the oil.
6. Remove the oil filter with a filter wrench and let the remaining oil drain out. Make sure the prior seal is not stuck to the engine.
  - Discard the oil and oil filter at an approved recycling centre.

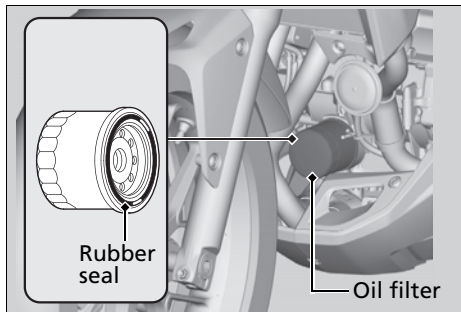

7. Apply a thin coat of engine oil to the rubber seal of a new oil filter.
8. Install a new oil filter and tighten.

**Torque:** 26 N·m (2.7 kgf·m, 19 lbf·ft).

9. Install a new sealing washer onto the drain bolt. Tighten the drain bolt.

**Torque:** 30 N·m (3.1 kgf·m, 22 lbf·ft).

10. Fill the crankcase with the recommended oil (► P. 48) and install the oil fill cap.

**Required oil**

**When changing oil & engine oil filter:**

2.7 litres (2.9 US qt, 2.4 Imp qt)

**When changing oil only:**

2.5 litres (2.6 US qt, 2.2 Imp qt)

11. Check the oil level. ► P. 60
12. Check that there are no oil leaks.

## Checking the Coolant

1. Place your motorcycle on a firm, level surface.
2. Hold your motorcycle in an upright position.
3. Check that the coolant level is between the UPPER and LOWER level marks in the reserve tank.

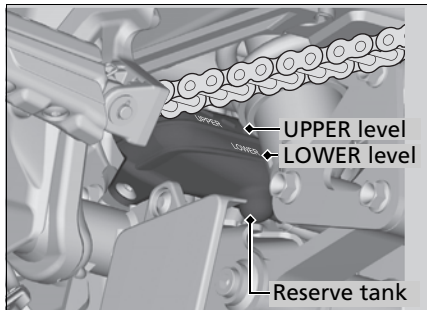

If the coolant level is dropping noticeably or the reserve tank is empty, you likely have a serious leak. Have your motorcycle inspected by your dealer.

## Adding Coolant

If the coolant level is below the LOWER level, add the recommended coolant (➡ P. 50) until the level reaches the UPPER level mark. Add fluid only from the reserve tank cap and do not remove radiator cap.

1. Remove the left side cover. ► P. 57
2. Remove the reserve tank cap and add fluid while monitoring the coolant level.
  - Do not overfill above the UPPER level mark.
  - Make sure no foreign objects enter the reserve tank opening.
3. Securely reinstall the cap.
4. Install the left side cover.

## **⚠ WARNING**

Removing the radiator cap while the engine is hot can cause the coolant to spray out, potentially scalding you.

Always let the engine and radiator cool down before removing the radiator cap.

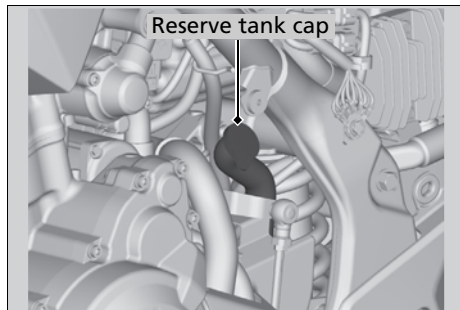

## **Changing Coolant**

Have your dealer change the coolant unless you have the proper tools and are mechanically qualified.

## Checking Brake Fluid

1. Place your motorcycle in an upright position on a firm, level surface.
2. **Front** Check that the brake fluid reservoir is horizontal and that the fluid level is above the LWR mark.  
**Rear** Check that the brake fluid reservoir is horizontal and that the fluid level is between the LOWER level and UPPER level marks.

If the brake fluid level in either reservoir is below the LWR or LOWER level mark or the brake lever and pedal freeplay becomes excessive, inspect the brake pads for wear. If the brake pads are not worn, you most likely have a leak. Have your motorcycle inspected by your dealer.

Front

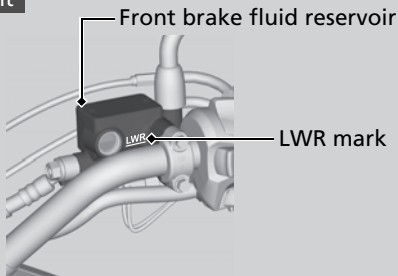

Rear

Rear brake fluid reservoir

UPPER level mark  
LOWER level mark

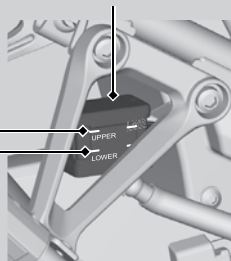

## Inspecting the Brake Pads

Check the condition of the brake pad groove wear indicators.

The pads need to be replaced if a brake pad is worn to the indicator.

1. **Front** Inspect the brake pads from below the brake caliper.
2. **Rear** Inspect the brake pads from the rear right of the motorcycle.

If necessary have the pads replaced by your dealer.

Always replace both left and right brake pads at the same time.

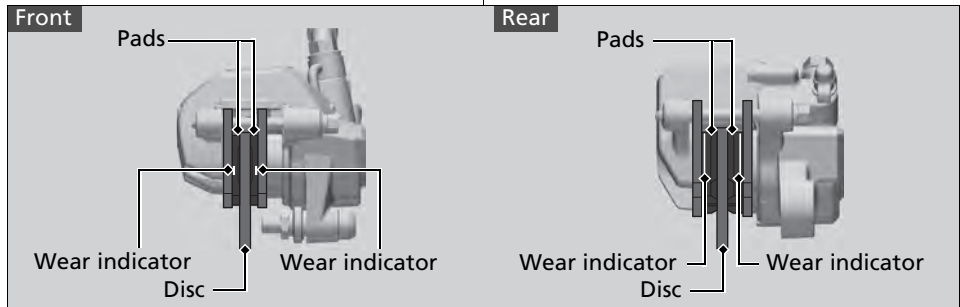

## Side Stand

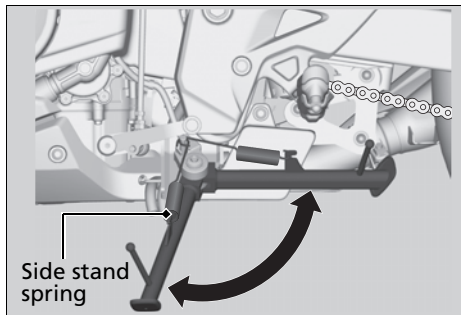

1. Check that the side stand operates smoothly. If the side stand is stiff or squeaky, clean the pivot area and lubricate the pivot bolt with clean grease.
2. Check the spring for damage or loss of tension.
3. Sit on the motorcycle, put the transmission in Neutral, and raise the side stand.
4. Start the engine, pull the clutch lever in, and shift the transmission into gear.
5. Lower the side stand all the way. The engine should stop as you lower the side stand. If the engine doesn't stop, have your motorcycle inspected by your dealer.

## Inspecting the Drive Chain Slack

Check the drive chain slack at several points along the chain. If the slack is not constant at all points, some links may be kinked and binding.

Have the chain inspected by your dealer.

1. Place your motorcycle on the side stand on a level surface.
2. Stop the engine. Place the transmission in Neutral.
3. Check the slack in the lower half of the drive chain midway between the sprockets.

### Drive chain slack:

35 to 45 mm (1.4 to 1.8 in)

- ▶ Do not ride your motorcycle if the slack exceeds 60 mm (2.4 in).

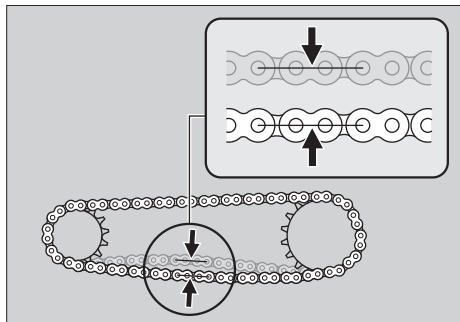

4. Roll the motorcycle forward and check that the chain moves smoothly.
5. Inspect the sprockets. ➤ P. 49
6. Clean and lubricate the drive chain. ➤ P. 50



## Adjusting the Drive Chain Slack

Adjusting the chain requires special tools. Have the drive chain slack adjusted by your dealer.

**CB500XA only**

When adjusting the drive chain slack, be careful not to damage the wheel speed sensor and pulser ring.

1. Place your motorcycle on the side stand on a level surface.
2. Stop the engine. Place the transmission in Neutral.
3. Loosen the rear axle nut.
4. Loosen the lock nuts on both sides of the swingarm.

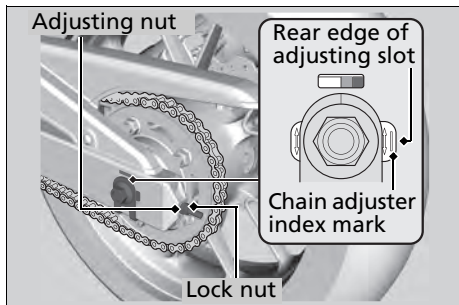
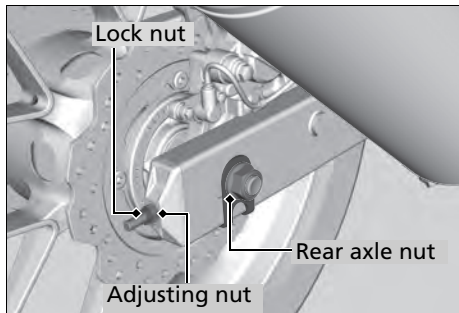

**Drive Chain ► Adjusting the Drive Chain Slack**

5. Turn both adjusting nuts an equal number of turns until the correct drive chain slack is obtained. Turn the adjusting nuts clockwise to tighten the chain. Turn the adjusting nuts counterclockwise to provide more slack.

Adjust the slack at a point midway between the front sprocket and the rear wheel sprocket.

Check the drive chain slack. ► P. 69

6. Check rear axle alignment by making sure the chain adjuster index marks align with the rear edge of the adjusting slots. Both marks should correspond. If the axle is misaligned, turn the right or left adjusting nuts until the marks are aligned and recheck chain slack.

7. Tighten the rear axle nut.

**Torque:** 88 N·m (9.0 kgf·m, 65 lbf·ft).

8. Tighten the drive chain adjusting nuts lightly, then hold the adjusting nuts and tighten the lock nuts.

**Torque:** 21 N·m (2.1 kgf·m, 15 lbf·ft).

9. Recheck drive chain slack.

If a torque wrench was not used for installation, see your dealer as soon as possible to verify proper assembly. Improper assembly may lead to loss of braking capacity.

## Checking the Drive Chain Wear

Check the chain wear label when adjusting the drive chain. If the index mark on the washer enters the red zone on the label after the chain has been adjusted to the proper slack, the chain is excessively worn and must be replaced.

**Chain:** DID 520V0

If necessary have the drive chain replaced by your dealer.

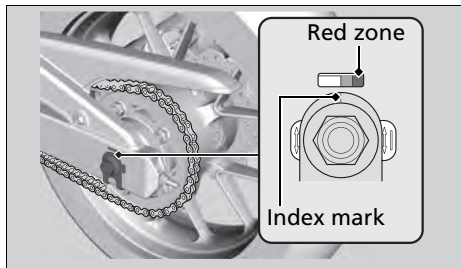

## Checking the Drive Chain Slider

Check the condition of the drive chain slider. The drive chain slider need to be replaced if it is worn to the wear limit line.

If necessary have the drive chain slider replaced by your dealer.

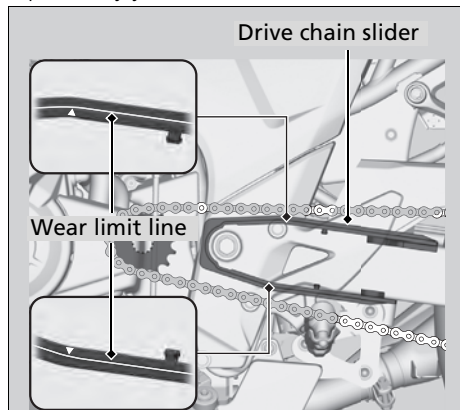

## Checking the Clutch

### Checking the Clutch Lever Freeplay

Check the clutch lever freeplay.

#### Freeplay at the clutch lever:

10 to 20 mm (0.4 to 0.8 in)

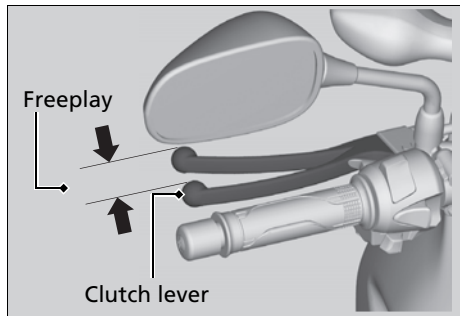

Check the clutch cable for kinks or signs of wear. If necessary have it replaced by your dealer.

Lubricate the clutch cable with a commercially available cable lubricant to prevent premature wear and corrosion.

## Adjusting the Clutch Lever Freeplay

### Upper Adjustment

Attempt adjustment with the upper clutch cable adjuster first.

1. Loosen the upper lock nut.
2. Turn the upper clutch cable adjuster until the freeplay is 10 to 20 mm (0.4 to 0.8 in).
3. Tighten the upper lock nut and check the freeplay again.

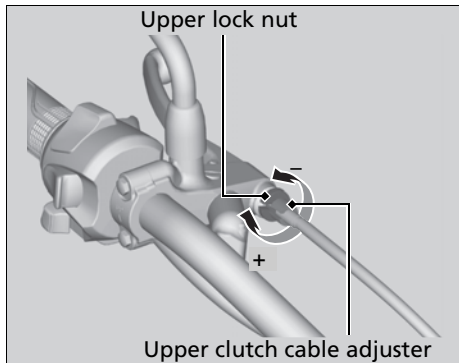

### Lower Adjustment

If the upper clutch cable adjuster is threaded out near its limit, or the correct freeplay cannot be obtained, attempt adjustment with the lower adjusting nut.

1. Loosen the upper lock nut and turn the upper clutch cable adjuster all the way in (to provide maximum freeplay). Tighten the upper lock nut.
2. Loosen the lower lock nut.
3. Turn the lower adjusting nut until the clutch lever freeplay is 10 to 20 mm (0.4 to 0.8 in).
4. Tighten the lower lock nut and check the clutch lever freeplay.
5. Start the engine, pull the clutch lever in, and shift into gear. Make sure the engine does not stall and the motorcycle does not creep. Gradually release the clutch lever and open the throttle. Your motorcycle should move smoothly and accelerate gradually.

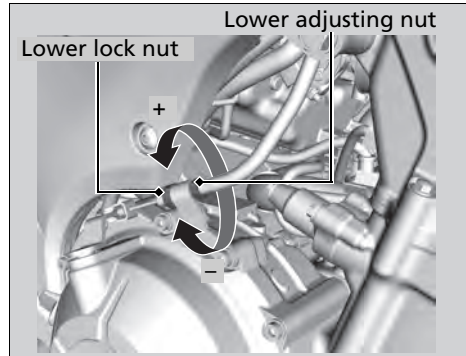

If proper adjustment cannot be obtained or the clutch does not work correctly, see your dealer.

## Checking the Throttle

With the engine off, check that the throttle rotates smoothly from fully closed to fully open in all steering positions and throttle freeplay is correct. If the throttle does not move smoothly, close automatically, or if the cable is damaged, have the motorcycle inspected by your dealer.

### **Freeplay at the throttle grip flange:**

2 to 6 mm (0.1 to 0.2 in).

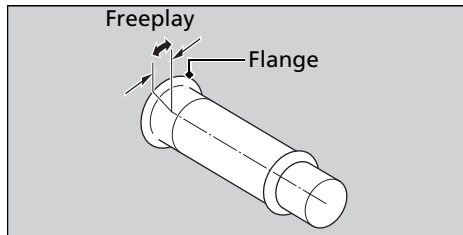

## Cleaning the Crankcase Breather

---

1. Remove the crankcase breather tube plug from the tube.
2. Drain deposits into a suitable container.
3. Install the crankcase breather tube plug.

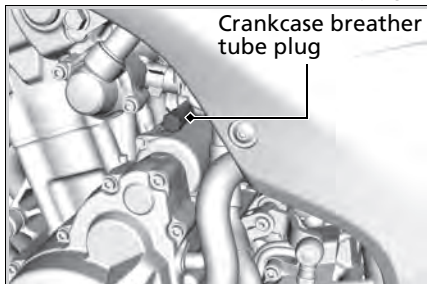



### Adjusting the Rear Suspension

#### Spring Preload

You can adjust the spring preload by the adjuster to suit the load or the road surface. Turn the adjuster using the pin spanner and extension bar provided in the tool kit.

(P. 55)

The preload adjuster has 9 positions.

The standard position is 3 when the index mark on the adjuster is aligned with the left end of the rear shock absorber lower mounting bolt.

Turn the adjuster in the direction A to decrease spring preload (soft) (position 1 to 2), or turn the adjuster in the direction B to increase spring preload (hard) (position 4 to 9).

Attempting to adjust directly from 1 to 9 or 9 to 1 may damage the shock absorber.

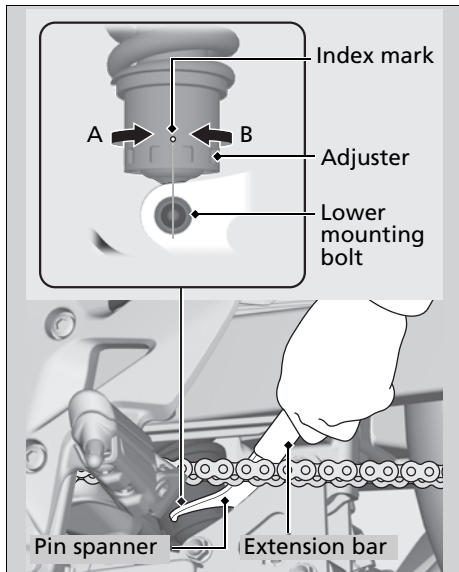

## Adjusting the Headlight Aim

You can adjust vertical aim of the headlight for proper alignment. Turn the pinion using a Phillips screwdriver provided in the tool kit (P. 55) in or out as necessary. Obey local laws and regulations.

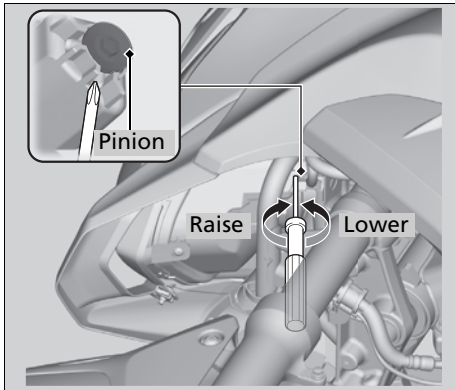

## Adjusting the Brakelight Switch

Check the operation of the brakelight switch. Hold the brakelight switch and turn the adjusting nut in the direction A if the switch operates too late, or turn the nut in the direction B if the switch operates too soon.

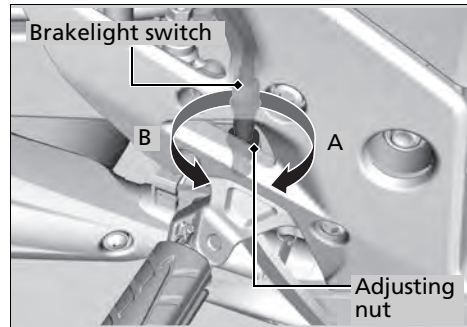

## Adjusting the Windscreen Height

You can adjust the windscreen height 2 positions.

1. Remove the upper side caps.

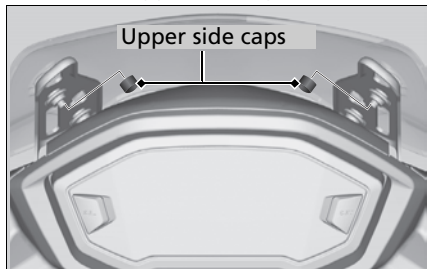

2. Remove the windscreen by removing the screws, the washers A.

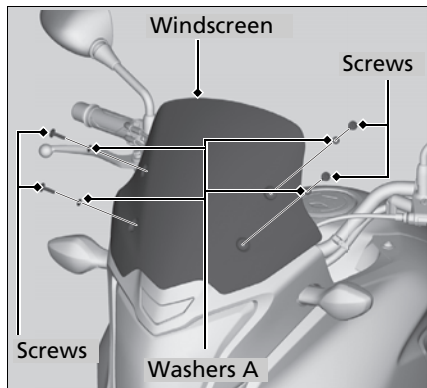

- Remove the nuts and the washers B.

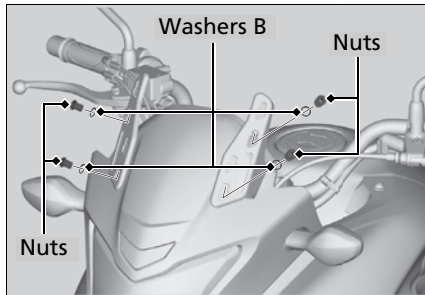

- Set the all nuts and the washers B to the low position holes or high position holes.

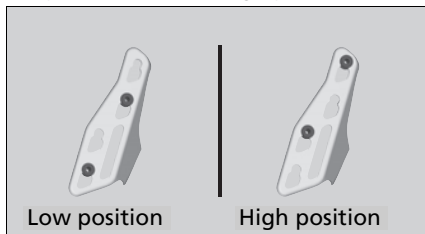

- Install the windscreen.
- Install and tighten the washers A and screws.
- Install the upper side caps.
- Make sure the installation order is the following illustration.

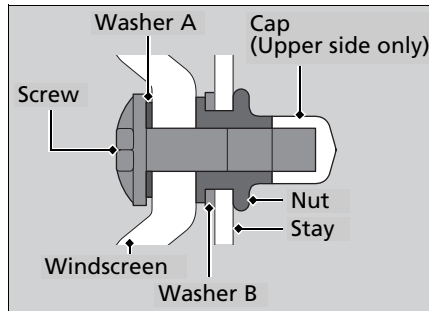

# Troubleshooting

<b>Engine Will Not Start (HISS indicator stays on)</b> .....	P. 83
<b>Overheating (High coolant temperature indicator is on)</b> .....	P. 84
<b>Warning Indicators On or Flashing</b> .....	P. 85
Low Oil Pressure Indicator.....	P. 85
PGM-FI (Programmed Fuel Injection)	
Malfunction Indicator Lamp (MIL) .....	P. 85
ABS (Anti-lock Brake System) Indicator (CB500XA only) .....	P. 86
<b>Other Warning Indication</b> .....	P. 87
Fuel Gauge Failure Indication.....	P. 87
<b>Tyre Puncture</b> .....	P. 88
<b>Electrical Trouble</b> .....	P. 95
Battery Goes Dead .....	P. 95
Burned-out Light Bulb .....	P. 95
Blown Fuse .....	P. 100

## Engine Will Not Start (HISS indicator stays on)

### I Starter Motor Operates But Engine Does Not Start

Check the following items:

- Check the correct engine starting sequence ➤ P. 34
- Check that there is petrol in the fuel tank
- Check if the PGM-FI malfunction indicator lamp (MIL) is on
  - ▶ If the indicator light is on, contact your dealer as soon as possible.
- Check if the HISS indicator stays on
  - ▶ Turn the ignition switch to the OFF position and remove the key. Reinsert the key and turn the ignition switch to the ON position. If the indicator still stays on, check the following:  
Check if there is no another HISS key (including spare key) close to the ignition switch.

Check if there are no any metallic seals or stickers on the key.

If the HISS indicator still stays on, have your motorcycle inspected by your dealer.

### I Starter Motor Does Not Operate

Check the following items:

- Make sure engine stop switch is  (Run) position ➤ P. 32
  - Check for a blown fuse ➤ P. 100
  - Check for a loose battery connection or battery terminal corrosion ➤ P. 46
  - Check the condition of the battery ➤ P. 95
- If the problem continues, have your motorcycle inspected by your dealer.

## Overheating (High coolant temperature indicator is on)

The engine is overheating when the following occurs:

- High coolant temperature indicator comes on
- Acceleration becomes sluggish
- If this occurs, pull safely to the side of the road and perform the following procedure. Extended fast idling may cause the high coolant temperature indicator comes on.

### NOTICE

Continuing to ride with an overheated engine can cause serious damage to the engine.

1. Stop the engine using the ignition switch, and then turn the ignition switch to the ON position.

2. Check that the radiator fan is operating, and then turn the ignition switch to the OFF position.

### If the fan is not operating:

Suspect a fault. Do not start the engine. Transport your motorcycle to your dealer.

### If the fan is operating:

Allow the engine to cool with the ignition switch in the OFF position.

3. After the engine has cooled, inspect the radiator hose and check if there is a leak.

➔ P. 64

### If there is a leak:

Do not start the engine. Transport your motorcycle to your dealer.

4. Check the coolant level in the reserve tank, and add coolant as necessary.

➔ P. 64

5. If 1-4 check normal, you may continue riding, but closely monitor the high coolant temperature indicator.

### Low Oil Pressure Indicator

---

If the low oil pressure indicator comes on, pull safely to the side of the road and stop the engine.

#### NOTICE

Continuing to ride with low oil pressure can cause serious damage to the engine.

1. Check the engine oil level, and add oil as necessary. ➤ P. 60
2. Start the engine.
  - ▶ Only continue riding if the low oil pressure indicator goes off.

Rapid acceleration may momentarily cause the low oil pressure indicator to come on, especially if the oil is at or near the low level. If the low oil pressure indicator stays on when the oil level is at the proper level, stop the engine and contact your dealer.

If the engine oil level goes down rapidly, your motorcycle may have a leak or another serious problem. Have your motorcycle inspected by your dealer.

### PGM-FI (Programmed Fuel Injection) Malfunction Indicator Lamp (MIL)

---

If the indicator comes on while riding, you may have a serious problem with the PGM-FI system. Reduce speed and have your motorcycle inspected by your dealer as soon as possible.



## ABS (Anti-lock Brake System) Indicator (CB500XA only)

---

If the indicator operates in one of the following ways, you may have a serious problem with the brake system. Reduce your speed and have your motorcycle inspected by your dealer as soon as possible.

- Indicator comes on or starts flashing while riding.
- Indicator does not come on when the ignition switch is in the ON position.
- Indicator does not go off at speeds above 10 km/h (6 mph).

If the ABS indicator stays on, your brakes will continue to work as a conventional system, but without the anti-locking function.

The ABS indicator may flash if you turn the rear wheel while your motorcycle is lifted off the ground. In this case, turn the ignition switch off and then on again. The ABS indicator will go off after your speed reaches 30 km/h (19 mph).

## Other Warning Indication

### Fuel Gauge Failure Indication

If the fuel system has an error, all segments will blink or go off as shown in the illustration.

If these occurs, see your dealer as soon as possible.

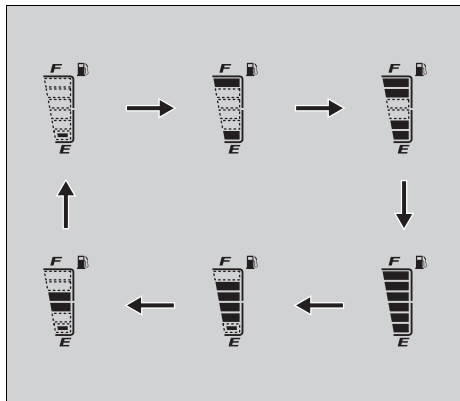
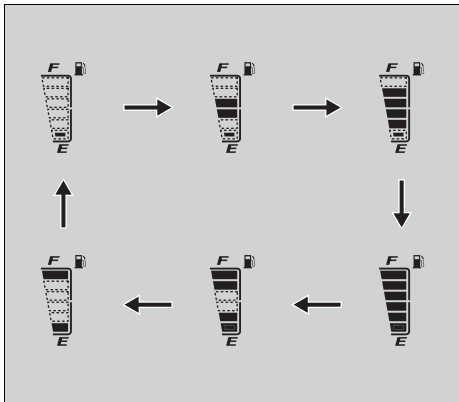

Repairing a puncture or removing a wheel requires special tools and technical expertise. We recommend you have this type of service performed by your dealer. After an emergency repair, always have the tyre inspected/replaced by your dealer.

### Emergency Repair Using a Tyre Repair Kit

---

If your tyre has a minor puncture, you can make an emergency repair using a tubeless tyre repair kit.

Follow the instructions provided with the emergency tyre repair kit.

Riding your motorcycle with a temporary tyre repair is very risky. Do not exceed 50 km/h (30 mph). Have the tyre replaced by your dealer as soon as possible.

### **WARNING**

Riding your motorcycle with a temporary tyre repair can be risky. If the temporary repair fails, you can crash and be seriously injured or killed.

If you must ride with a temporary tyre repair, ride slowly and carefully and do not exceed 50 km/h (30 mph) until the tyre is replaced.

### Removing Wheels

---

Follow these procedures if you need to remove a wheel in order to repair a puncture.

**CB500XA only**

When removing and installing the wheel, be careful not to damage the wheel speed sensor and pulser ring.

**Front Wheel****Removal**

1. Park on a firm, level surface.
2. Cover the right side of the front wheel and brake caliper with protective tape or cloth.
3. On the right side, remove the mounting bolts and brake caliper.
  - Support the brake caliper assembly so that it doesn't hang from the brake hose. Do not twist the brake hose.
  - Avoid getting grease, oil, or dirt on the disc or pad surfaces.
  - Do not pull the brake lever while the brake caliper is removed.

- Take care to prevent the brake caliper from scratching the wheel during removal.

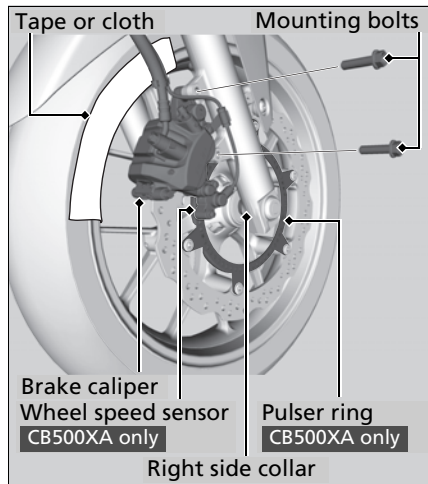

4. Loosen the axle pinch bolt and front axle shaft.
5. Support your motorcycle securely and raise the front wheel off the ground using a maintenance stand or a hoist.
6. Remove the front axle shaft, front wheel and side collars.

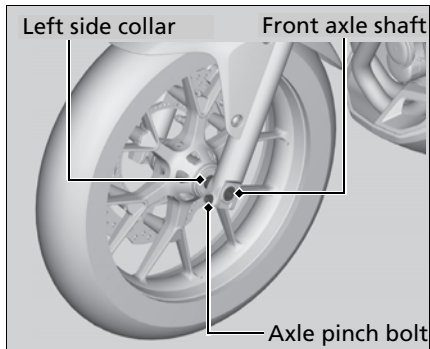

### Installation

1. Attach the right and left side collars in their original locations on the wheel.
2. On the left side, place the wheel between the fork legs and insert the front axle shaft to the end, through the left fork leg and wheel hub.
3. Tighten the axle shaft.

**Torque:** 54 N·m (5.5 kgf·m, 40 lbf·ft).

4. Install the brake caliper and tighten the mounting bolts.

**Torque:** 30 N·m (3.1 kgf·m, 22 lbf·ft).

- Take care to prevent the brake caliper from scratching the wheel during installation.
- Use new mounting bolts when installing the brake caliper.

**NOTICE**

When installing the brake caliper into position on the fork leg, carefully fit the brake disc between the pads to avoid scratching them.

5. Lower the front wheel on the ground.
6. Apply the brake lever and pump the fork several times.
7. Tighten the axle pinch bolt.

**Torque:** 22 N·m (2.2 kgf·m, 16 lbf·ft).

8. Raise the front wheel off the ground again, and check that the wheel rotates freely after you release the brake.
9. Uncover the protective tape or cloth.

If a torque wrench was not used for installation, see your dealer as soon as possible to verify proper assembly. Improper assembly may lead to loss of braking capacity.

## Rear Wheel

### Removal

1. Support your motorcycle securely and raise the rear wheel off the ground using a maintenance stand or a hoist.
2. Loosen the rear axle nut, lock nuts and turn the adjusting nuts so the rear wheel can be moved all the way forward for maximum drive chain slack.
3. Remove the drive chain from the rear wheel sprocket by pushing the rear wheel forward.
4. Remove the rear axle nut and washer.

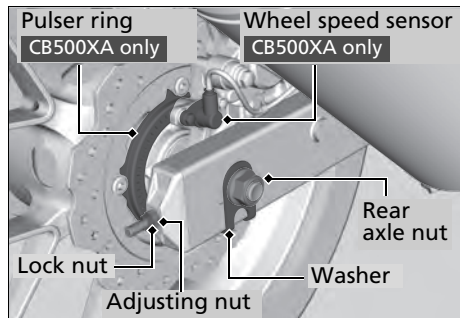
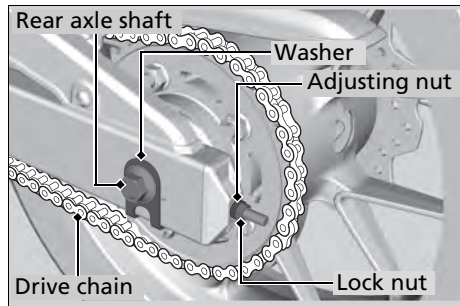

5. Remove the rear axle shaft, washer, brake caliper bracket, rear wheel and side collars.
  - Support the brake caliper assembly so that it doesn't hang from the brake hose. Do not twist the brake hose.
  - Avoid getting grease, oil, or dirt on the disc or pad surfaces.
  - Do not push the brake pedal while the brake caliper is removed.

## Installation

1. To install the rear wheel, reverse the removal procedure.
  - Take care to prevent the brake caliper from scratching the wheel during installation.

### NOTICE

When installing the brake caliper into position, carefully fit the brake disc between the pads to avoid scratching them.



2. Make sure that the slot on the brake caliper bracket is positioned in the lug on the swingarm.

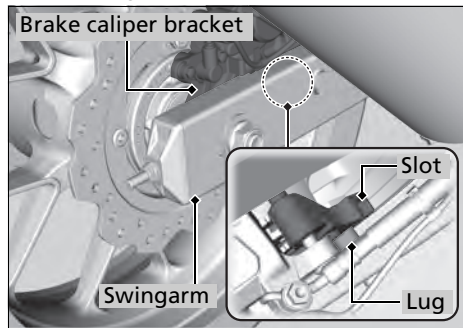

3. Adjust the drive chain. ► P. 70
4. Tighten the rear axle nut.

**Torque:** 88 N·m (9.0 kgf·m, 65 lbf·ft).

5. Tighten the drive chain adjusting nuts lightly, then hold the adjusting nuts and tighten the lock nuts.

**Torque:** 21 N·m (2.1 kgf·m, 15 lbf·ft).

6. After installing the wheel, apply the brake pedal several times, then check if the wheel rotates freely. Recheck the wheel if the brake drags or if the wheel does not rotate freely.

If a torque wrench was not used for installation, see your dealer as soon as possible to verify proper assembly. Improper assembly may lead to loss of braking capacity.

### Battery Goes Dead

---

Charge the battery using a motorcycle battery charger.

Remove the battery from the motorcycle while charging.

Do not use an automobile-type battery charger, as these can overheat a motorcycle battery and cause permanent damage.

If the battery does not recover after recharging, contact your dealer.

#### NOTICE

Jump starting using an automobile battery is not recommended, as this can damage your motorcycle's electrical system.

### Burned-out Light Bulb

---

Follow the procedure below to replace a burned-out light bulb.

Turn the ignition switch to the OFF or LOCK position.

Allow the bulb to cool before replacing it.

Do not use bulbs other than those specified.

Check the replacement bulb for correct operation before riding.

For the light bulb wattage, see

"Specifications." ➤ P. 116

## Headlight Bulb

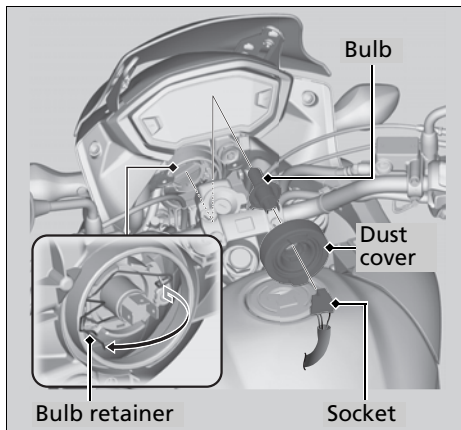

1. Remove the bulb lid. ► P. 58
2. Pull off the socket without turning.
3. Remove the dust cover.
4. Unhook the bulb retainer and pull out the bulb without turning it.
5. Install a new bulb and parts in the reverse order of removal.

Do not touch the glass surface with your fingers. If you touch the bulb with your bare hands, clean it with a cloth moistened with alcohol.

## Position Light Bulb

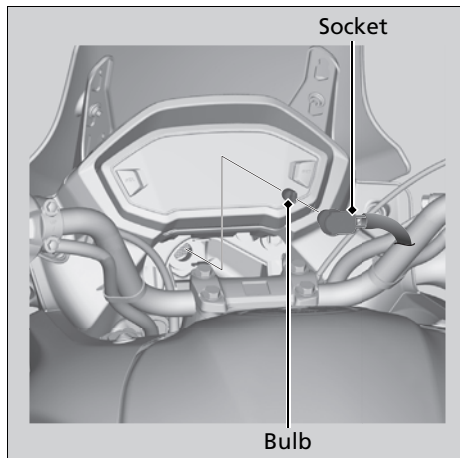

1. Remove the bulb lid. ► P. 58
2. Pull off the socket without turning.
3. Pull out the bulb without turning.
4. Install a new bulb and parts in the reverse order of removal.

## Brake/Tail Light Bulb

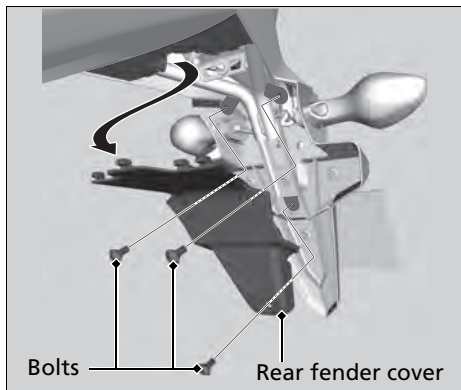

1. Remove the bolts and rear fender cover.

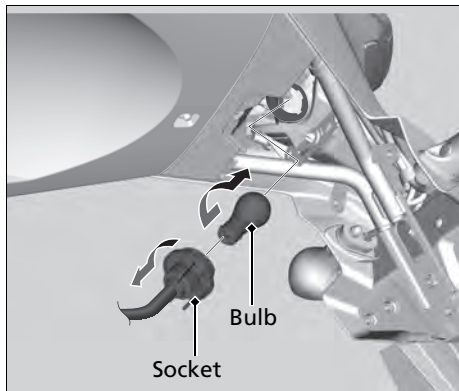

2. Turn the socket counterclockwise, and remove it.
3. Slightly press the bulb and turn it counterclockwise.
4. Install a new bulb and parts in the reverse order of removal.

## Front/Rear Turn Signal Bulb

1. Remove the screw and collar.
2. Remove the turn signal lens.
3. Slightly press the bulb and turn it counterclockwise.

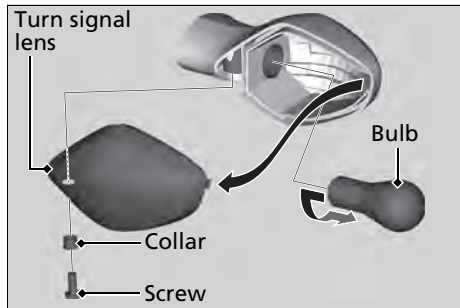

4. Install a new bulb and parts in the reverse order of removal.
  - Use only the amber bulb.

## License Plate Light

1. Remove the screws, license light cover and license light cover packing.
2. Pull out the bulb without turning.

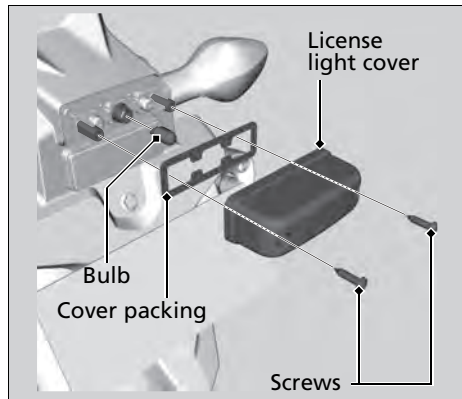

3. Install a new bulb and parts in the reverse order of removal.

## Blown Fuse

Before handling fuses, see "Inspecting and Replacing Fuses." ▶ P. 47

### Fuse Box Fuses

1. Remove the seat. ▶ P. 56
2. Remove the fuse box covers.
3. Pull the fuses out with the fuse puller in the tool kit one by one check for a blown fuse. Always replace a blown fuse with a spare of the same rating.
4. Install the fuse box covers.
5. Install the seat.

CB500X

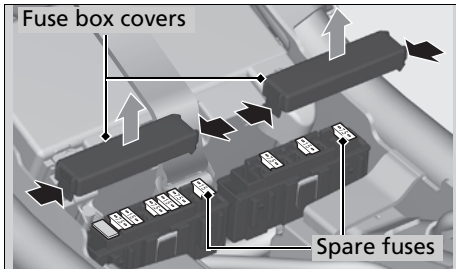

CB500XA

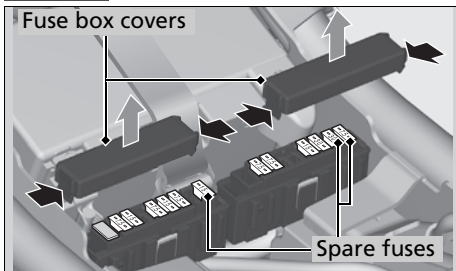

## I Main Fuse

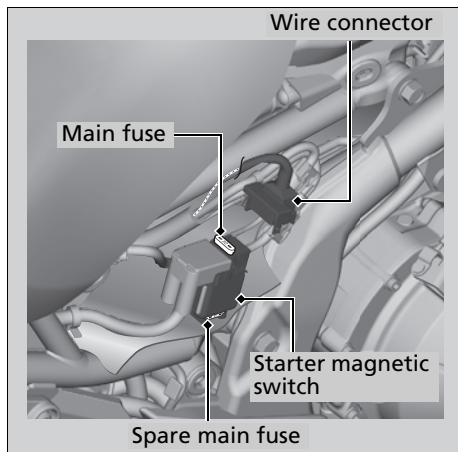

1. Remove the right side cover. ► P. 57
2. Disconnect the wire connector of the starter magnetic switch.

3. Pull the main fuse out and check for a blown fuse. Always replace a blown fuse with a spare of the same rating.
  - Spare main fuse is provided in the starter magnetic switch.
4. Reinstall parts in the reverse order of removal.

### NOTICE

If a fuse fails repeatedly, you likely have an electrical problem. Have your motorcycle inspected by your dealer.



# Information

<b>Keys.....</b>	<b>P. 103</b>
<b>Instruments, Controls, &amp; Other Features....</b>	<b>P. 104</b>
<b>Fuels Containing Alcohol.....</b>	<b>P. 106</b>
<b>Catalytic Converter .....</b>	<b>P. 107</b>
<b>Caring for Your Motorcycle.....</b>	<b>P. 108</b>
<b>Storing Your Motorcycle .....</b>	<b>P. 110</b>
<b>Transporting Your Motorcycle .....</b>	<b>P. 111</b>
<b>You &amp; the Environment.....</b>	<b>P. 112</b>
<b>Serial Numbers .....</b>	<b>P. 113</b>

# Keys

## Ignition key

The ignition key contains a special coded chip that is recognized by the immobilizer system (HISS) in order to start the engine. Handle the key carefully to prevent damaging the HISS components.

- Do not bend keys or subject them to undue stress.
- Avoid prolonged exposure to sunlight or high temperatures.
- Do not grind, drill or in any way alter their shape.
- Do not expose to strong magnetic objects.

If you lose all keys and the key number plate, the PGM-FI unit/ignition control module must be replaced by your dealer. To avoid this, keep a duplicate key.

If you lose a key, make another duplicate key immediately.

To make a duplicate key and register it with your HISS system, take the spare key, the key number plate, and the motorcycle to your dealer.

A metal key holder may cause damage to the area surrounding the ignition switch.

## Instruments, Controls, & Other Features

### Ignition Switch

The headlight is always on when the ignition switch is on. Leaving the ignition switch on with the engine stopped will drain the battery. Do not turn the key while riding.

### Engine Stop Switch

Do not use the engine stop switch except in an emergency. Doing so when riding will cause the engine to suddenly turn off, making riding unsafe.

If you stop the engine using the engine stop switch, turn the ignition switch off. Failing to do so will drain the battery.

### Odometer

The display locks at 999999 when the read-out exceeds 999999.

### Tripmeter

The tripmeter A, B returns to 0.0 when the read-out exceeds 9999.9.

### HISS

The Honda Ignition Security System (HISS) immobilizes the engine's ignition system if an improperly-coded key is used to try and start the engine. When the ignition switch is turned off, the HISS immobilizer system is always alert, even if the HISS indicator is not flashing. If the ignition switch is turned on with the engine stop switch in the  (Run) position, the HISS indicator turns on and goes off after a few seconds to indicate it is OK to start the engine.

**❗ HISS Indicator Does Not Turn Off** P. 83

The HISS indicator starts flashing every 2 seconds for 24 hours after the ignition switch is turned off. You can turn this feature on and off.

**❗** P. 28

## EC Directive

This immobilizer system complies with R & TTE (Radio and Telecommunications Terminal Equipment and the mutual recognition of their conformity) Directive.



The declaration of conformity to R & TTE Directive is provided to the owner at the time of purchase. The declaration of conformity should be kept at a safe place. When the declaration of conformity is lost or is not provided, contact your dealer.

### South Africa only



### Singapore only



### Morocco only



## Document Bag

The owner's manual, registration, and insurance information can be stored in the plastic document bag underside of the seat.

➤ P. 38

## Ignition Cut-off System

A banking (lean angle) sensor automatically stops the engine and fuel pump if the motorcycle falls over. To reset the sensor, you must turn the ignition switch to OFF and back to the ON position before the engine can be restarted.

# Fuels Containing Alcohol

Some conventional fuels blended with alcohol are available in some locales to help reduce emissions to meet clean air standards. If you plan to use blended fuel, check that it is unleaded and meets the minimum octane rating requirement.

The following fuel blends can be used in your motorcycle:

- Ethanol (ethyl alcohol) 10% by volume (max).
- Petrol containing ethanol may be marketed under the name Gasohol.
- Methanol (methyl alcohol) 5% by volume (max) that contain cosolvents and corrosion inhibitors to protect the fuel system. Never use a blend containing more than 5%.

The use of petrol containing more than 10% ethanol (or more than 5% methanol) may:

- Damage the painting of the fuel tank.
- Damage the rubber tubes of the fuel line.
- Cause corrosion of the fuel tank.
- Cause poor drivability.

### NOTICE

Use of blended fuels containing higher than approved percentages can damage metal, rubber, plastic parts of your fuel system.

If you notice any undesirable operating symptoms or performance problems, try a different brand of petrol.

## Catalytic Converter

This motorcycle is equipped with a three-way catalytic converter. The catalytic converter contain precious metals that serve as catalysts in high temperature chemical reactions that convert hydrocarbons (HC), carbon monoxide (CO), and oxides of nitrogen (NOx) in the exhaust gasses into safe compounds.

A defective catalytic converter contributes to air pollution and can impair your engine's performance. A replacement unit must be an original Honda part or equivalent.

Follow these guidelines to protect your motorcycle's catalytic converter.

- Always use unleaded petrol. Leaded petrol will damage the catalytic converter.
- Keep the engine in good running condition.
- Have your motorcycle serviced if your engine is misfiring, backfiring, stalling, or otherwise not running properly, stop riding and turn off the engine.

## Caring for Your Motorcycle

Frequent cleaning and polishing is important to ensure the long life of your Honda. A clean motorcycle makes it easier to spot potential problems.

In particular, seawater and salts used to prevent ice on roads promote the formation of corrosion. Always wash your motorcycle thoroughly after riding on coastal or treated roads.

### Washing

Allow the engine, muffler, brakes, and other high-temperature parts to cool before washing.

1. Rinse your motorcycle thoroughly using a garden hose to remove loose dirt.
2. If necessary, use a sponge or a soft towel with mild cleaner to remove road grime.
  - ▶ Clean the windscreen, headlight lens, panels, and other plastic components with extra care to avoid scratching them. Avoid

directing water into the air cleaner, muffler, and electrical parts.

3. Thoroughly rinse your motorcycle with plenty of clean water and dry with a soft, clean cloth.
4. After the motorcycle dries, lubricate any moving parts.
  - ▶ Make sure that no lubricant spills onto the brakes or tyres. Brake discs or pads contaminated with oil suffer greatly reduced braking effectiveness and can lead to a crash.
5. Lubricate the drive chain immediately after washing and drying the motorcycle.
6. Apply a coat of wax to prevent corrosion.
  - ▶ Avoid products that contain harsh detergents or chemical solvents. These can damage the metal, paint, and plastic on your motorcycle.
  - Keep the wax clear of the tyres and brakes.
  - ▶ If your motorcycle has any matte painted parts, do not apply a coat of wax to the matte painted surface.

## Washing Precautions

Follow these guidelines when washing:

- Do not use high-pressure washers:
  - ▶ High-pressure water cleaners can damage moving parts and electrical parts, rendering them inoperable.
- Do not direct water at the muffler:
  - ▶ Water in the muffler can prevent starting and causes rust in the muffler.
- Dry the brakes:
  - ▶ Water adversely affects braking effectiveness. After washing, apply the brakes intermittently at low speed to help dry them.
- Do not direct water under the seat:
  - ▶ Water in the under seat compartment can damage your documents and other belongings.
- Do not direct water at the air cleaner:
  - ▶ Water in the air cleaner can prevent the engine from starting.
- Do not direct water near the headlight:
  - ▶ Any condensation inside the headlight

should dissipate after a few minutes of running the engine.

- Do not use waxes containing compounds at the matte painted surface:
  - ▶ Using plenty of water, clean the matte painted surface with a soft cloth or sponge. Dry with a soft, clean cloth.
  - ▶ Use neutral detergent to clean matte painted surface.

## Aluminium Components

Aluminium will corrode from contact with dirt, mud, or road salt. Clean aluminium parts regularly and follow these guidelines to avoid scratches:

- Do not use stiff brushes, steel wool, or cleaners containing abrasives.
- Avoid riding over or scraping against curbs.

## Panels and Windscreen

Follow these guidelines to prevent scratches and blemishes:



## Storing Your Motorcycle

- Wash gently using a soft sponge and plenty of water.
- To remove stubborn stains, use diluted detergent and rinse thoroughly with plenty of water.
- Avoid getting petrol, brake fluid, or detergents on the instruments, windscreen, panels, or headlight.

### Exhaust Pipe and Muffler

The exhaust pipe and muffler are stainless steel but may become stained by mud or dust.

To remove mud or dust, use a wet sponge and a liquid kitchen abrasive, then rinse well with clean water. Dry with chamois or a soft towel. If necessary, remove heat stains by using a commercially available fine texture compound. Then rinse by the same manner as removing mud or dust.

#### NOTICE

Even though the exhaust is made of stainless steel, it can become stained. Remove all marks and blemishes as soon as they are noticed.

## Storing Your Motorcycle

If you store your motorcycle outdoors, you should consider using a full-body motorcycle cover.

If you won't be riding for an extended period, follow these guidelines:

- Wash your motorcycle and wax all painted surfaces (except matte painted surfaces). Coat chrome pieces with rust-inhibiting oil.
- Lubricate the drive chain. ➤ P. 50
- Place your motorcycle on a maintenance stand and position a block so that both tyres are off the ground.
- After rain, remove the body cover and allow the motorcycle to dry.
- Remove the battery (➤ P. 59) to prevent discharge. Charge the battery in a shaded, well-ventilated area.
  - ▶ If you leave the battery in place, disconnect the negative ⊖ terminal to prevent discharge.

After removing your motorcycle from storage, inspect all maintenance items required by the Maintenance Schedule.

## Transporting Your Motorcycle

If your motorcycle needs to be transported, it should be carried on a motorcycle trailer or a flatbed truck or trailer that has a loading ramp or lifting platform, and motorcycle tie-down straps. Never try to tow your motorcycle with a wheel or wheels on the ground.

### NOTICE

Towing your motorcycle can cause serious damage to the transmission.

## You & the Environment

Owning and riding a motorcycle can be enjoyable, but you must do your part to protect the environment.

### Choose Sensible Cleaners

Use a biodegradable detergent when you wash your motorcycle. Avoid aerosol spray cleaners that contain chlorofluorocarbons (CFCs) which damage the atmosphere's protective ozone layer.

### Recycle Wastes

Put oil and other toxic wastes in approved containers and take them to a recycling centre. Call your local or state office of public works or environmental services to find a recycling centre in your area, and to get instructions on how to dispose of non-recyclable wastes. Do not place used engine oil in the trash, or pour it down a

drain or on the ground. Used oil, petrol, coolant, and cleaning solvents contain poisons that can hurt refuse workers and contaminate drinking water, lakes, rivers, and oceans.

## Serial Numbers

The frame and engine serial numbers uniquely identify your motorcycle and are required in order to register your motorcycle. They may also be required when ordering replacement parts. The frame number is stamped on the right side of the steering head.

The engine number is stamped on top of the crankcase.

You should record these numbers and keep them in a safe place.

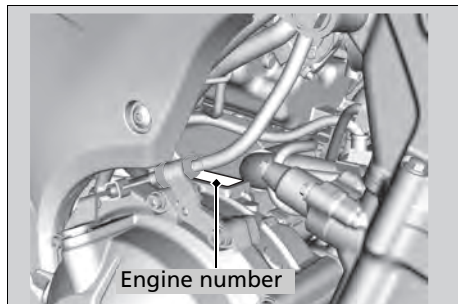
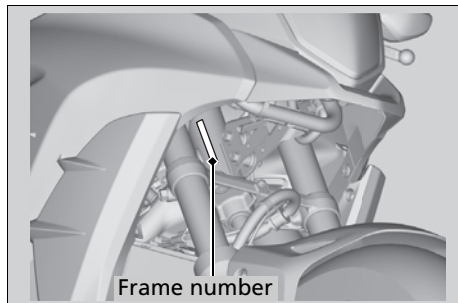

# Specifications

## ■ Main Components

Type	PC46	
Overall length	2,095 mm (82.5 in)	
Overall width	830 mm (32.7 in)	
	Windscreen position	
Overall height	Low	1,260 mm (49.6 in)
	High	1,290 mm (50.8 in)
Wheelbase	1,420 mm (55.9 in)	
Minimum ground clearance	170 mm (6.7 in)	
Caster angle	26° 30'	
Trail	108 mm (4.3 in)	
Curb weight	Except KO type	
	CB500X	192 kg (423 lb)
	CB500XA	194 kg (428 lb)
	KO type	
	CB500X	190 kg (419 lb)
	CB500XA	195 kg (430 lb)
Maximum weight capacity*1	Except KO type	185 kg (408 lb)
	KO type	160 kg (353 lb)
Maximum luggage weight *2	Except KO type	11 kg (24 lb)

\*1 Including rider, passenger, all luggage, and accessories

\*2 Includes the weight of the luggage and added accessories

Passenger capacity	Rider and 1 passenger	
Minimum turning radius	2.8 m (9.2 ft)	
Displacement	471 cm <sup>3</sup> (28.7 cu-in)	
Bore x stroke	67.0 x 66.8 mm (2.64 x 2.63 in)	
Compression ratio	10.7:1	
Fuel	Unleaded petrol	
	Recommended: 91 RON or higher	
Tank capacity	Except KO type	17.3 litres (4.57 US gal, 3.81 Imp gal)
	KO type	17.0 litres (4.49 US gal, 3.74 Imp gal)
	FTZ10S	
Battery	12V-8.6 Ah (10 HR) / 9.1 Ah (20 HR)	
	YTZ10S	
	12V-8.6 Ah (10 HR) / 9.1 Ah (20 HR)	
	1st	3.285
Gear ratios	2nd	2.105
	3rd	1.600
	4th	1.300
	5th	1.150
	6th	1.043
	Reduction ratios (primary / final)	2.029 / 2.733

■ Service Data

Tyre size	Front	120/70ZR17M/C 58W
	Rear	160/60ZR17M/C 69W
Tyre type	Radial, tubeless	
Recommended Tyres	Front	PIRELLI SCORPION TRAIL E
	Rear	PIRELLI SCORPION TRAIL
Tyre air pressure	Front	250 kPa (2.50 kgf/cm <sup>2</sup> , 36 psi)
	Rear	290 kPa (2.90 kgf/cm <sup>2</sup> , 42 psi)
Minimum tread depth	Front	1.5 mm (0.06 in)
	Rear	2.0 mm (0.08 in)
Spark plugs	(standard) CPR8EA-9 (NGK)	
Spark plug gap	0.80 to 0.90 mm (0.031 to 0.035 in)	
Idle speed	1,200 ± 100 rpm	
Recommended engine oil	Honda 4-stroke motorcycle oil API Service Classification SG or higher, excluding oils marked as "Energy Conserving" or "Resource Conserving," SAE 10W-30, JASO T 903 standard MA	

Engine oil capacity	After draining	2.5 litres (2.6 US qt, 2.2 Imp qt)
	After draining & engine oil filter change	2.7 litres (2.9 US qt, 2.4 Imp qt)
	After disassembly	3.2 litres (3.4 US qt, 2.8 Imp qt)
Recommended brake fluid	Honda DOT 4 Brake Fluid	
Cooling system capacity	1.40 litres (1.48 US qt, 1.23 Imp qt)	
Recommended coolant	Pro Honda HP Coolant	
Recommended drive chain lubricant	Drive chain lubricant designed specifically for O-ring chains. If not available, use SAE 80 or 90 gear oil.	
Drive chain slack	35 to 45 mm (1.4 to 1.8 in)	
Standard drive chain	DID 520V0	
	No. of links	112
Standard sprocket sizes	Engine sprocket	15T
	Rear wheel sprocket	41T

## Specifications

### ■ Bulbs

Headlight	12V-60/55W
Brake/Tail light	12V-21/5W
Front turn signal lights	12V-21W × 2
Rear turn signal lights	12V-21W × 2
Position lights	12V-5W
License plate light	12V-5W

### ■ Fuses

Main fuse	30A
Other fuses	CB500X      15A, 7.5A
	CB500XA      30A, 15A, 7.5A

### ■ Torque Specifications

Engine oil drain bolt	30 N·m (3.1 kgf·m, 22 lbf·ft)
Oil filter	26 N·m (2.7 kgf·m, 19 lbf·ft)
Front wheel axle shaft	54 N·m (5.5 kgf·m, 40 lbf·ft)
Front wheel brake caliper mounting bolts	30 N·m (3.1 kgf·m, 22 lbf·ft)
Front wheel axle pinch bolt	22 N·m (2.2 kgf·m, 16 lbf·ft)
Rear wheel axle nut	88 N·m (9.0 kgf·m, 65 lbf·ft)
Drive chain adjusting lock nuts	21 N·m (2.1 kgf·m, 15 lbf·ft)

- A**  
ABS (Anti-lock Brake System)  
  Indicator ..... 30, 86  
Accessories..... 14  
Anti-lock Brake System (ABS)..... 12
- B**  
Battery ..... 46, 59  
Brakelight Switch..... 79  
Brakes  
  Fluid..... 49, 66  
  Pad Wear ..... 67  
Braking ..... 11  
Bulb  
  Brake/Tail Light ..... 98  
  Front Turn Signal..... 99  
  Headlight..... 96  
  License Plate Light..... 99  
  Position Light ..... 97  
  Rear Turn Signal..... 99  
Bulb Lid..... 58
- C**  
Caring for Your Motorcycle..... 108  
Catalytic Converter..... 107  
Clutch System ..... 73  
Coolant ..... 50, 64  
Crankcase Breather ..... 77
- D**  
Digital Clock Adjustment..... 25  
Drive Chain ..... 69
- E**  
Electrical Trouble..... 95  
Engine  
  Number..... 113  
  Oil ..... 48, 60  
  Oil Filter..... 62  
  Overheats..... 84  
  Starting ..... 34  
  Stop Switch ..... 32, 34, 104  
  Stopping ..... 104  
Environment..... 112



<b>Equipment</b>		<b>Headlight Aim</b> .....	79
Owner's Manual.....	105	<b>Headlight Dimmer Switch</b> .....	32
Tool Kit.....	55	<b>Helmet Holder</b> .....	37
<b>F</b>		<b>High Beam Indicator</b> .....	31
<b>Flooded Engine</b> .....	34	<b>High Coolant Temperature</b>	
<b>Frame Number</b> .....	113	Indicator.....	30, 84
<b>Fuel</b>		<b>HISS Indicator</b> .....	31, 83
Consumption Meter.....	20	<b>Horn Button</b> .....	32
Gauge.....	19		
Mileage Meter.....	20	<b>I</b>	
Recommended.....	36	<b>Ignition Cut-off System</b>	
Remaining.....	19, 20	Banking Sensor.....	105
Tank Capacity.....	36	Side Stand.....	68
<b>Fuels Containing Alcohol</b> .....	106	<b>Ignition key</b> .....	103
<b>Fuses</b> .....	47, 100	<b>Ignition Switch</b> .....	33, 34
		<b>Image Labels</b> .....	6
		<b>Indicators</b> .....	30
		<b>Instruments</b> .....	18
<b>G</b>			
<b>Gasohol</b> .....	106	<b>L</b>	
<b>Gasoline</b> .....	36	<b>Labels</b> .....	6
		<b>Load Limits</b> .....	15
<b>H</b>		<b>Loading Guidelines</b> .....	15
<b>Hazard Switch</b> .....	32		

Low Oil Pressure Indicator..... 30, 85

## **M**

### **Maintenance**

Fundamentals ..... 44

Importance ..... 40

Safety ..... 40

Schedule ..... 41

Maximum Weight Limit..... 15

Modifications ..... 14

## **N**

Neutral Indicator..... 31

## **O**

Odometer ..... 20, 104

### **Oil**

Engine ..... 48, 60

Overheating ..... 84

## **P**

Parking ..... 13

Parts Location..... 16

Passing Light Control Switch ..... 32

Petrol..... 106

### **PGM-FI (Programmed Fuel Injection)**

malfunction indicator lamp (MIL) .... 30, 85

Protective Apparel ..... 10

## **R**

Rear Suspension ..... 78

### **Recommended**

Coolant ..... 50

Fuel ..... 36

Oil ..... 48

Refuelling ..... 36

### **Removal**

Battery ..... 59

Bulb Lid ..... 58

Clip ..... 58

Seat..... 56

Side Cover..... 57

Repair Kit..... 88

Riding Precautions ..... 11

<b>S</b>	
Safety Precautions.....	10
Seat .....	56
Serial Numbers .....	113
Shifting Gears.....	35
Side Cover .....	57
Side Stand.....	68
Side Stand Ignition Cut-off System .....	68
Specifications.....	114
Speedometer .....	19
Start Button .....	32, 34
Starting the Engine .....	34
Steering Lock.....	33
Stopping Engine.....	104
Storage	
Equipment.....	37
Owner's Manual.....	38, 105
Tool Kit .....	38
Storing Your Motorcycle.....	110
Switches .....	32
<b>T</b>	
Tachometer.....	19
Throttle .....	76
Tool Kit.....	55
Transporting Your Motorcycle.....	111
Tripmeter .....	20, 104
Troubleshooting .....	82
Turn Signal Indicators.....	31
<b>Tyres</b>	
Air Pressure.....	51
Puncture .....	88
Replacing.....	51, 88
<b>W</b>	
Warning Indicators On .....	85
Washing Your Motorcycle.....	108
Weight Limit .....	15
<b>Wheels</b>	
Front removal .....	89
Rear removal.....	92
Windscreen .....	80